



JOINT IMPLEMENTATION PROJECT DESIGN DOCUMENT FORM
Version 01 – in effect as of: 15 June 2006

CONTENTS

- A. General description of the project
- B. Baseline
- C. Duration of the project / crediting period.
- D. Monitoring plan
- E. Estimation of greenhouse gas emission reductions
- F. Environmental impacts
- G. Stakeholders' comments

Annexes

- Annex 1: Contact information on project participants
- Annex 2: Baseline information
- Annex 3: Monitoring plan
- Annex 4: Extracts from the “Reference book of quality indicators, volume of coal production and beneficiation products in 2008-2010”
- Annex 5: Reference of the State Statistics Service of Ukraine “Actual expenses of electricity for production of one ton of non-agglomerated coal”
- Annex 6: Additional information on project participants

**SECTION A. General description of the project****A.1. Title of the project:**

Carbonaceous rock processing and concentrating with the aim of reducing greenhouse gas emissions into the atmosphere

The sectoral scope: (8) Mining/mineral production

The version number of the document: 2.0

The date of the document: 22th of November 2012

A.2. Description of the project:**General provisions on the problem of waste heap formation:**

Coal is mainly found on the territory of Donbas at the average depth of 400-800 m, and average thickness of coal-bed is 0.6-1.2 m. The method of extraction is mainly based on the mine extracting. The majority of mines operate on the depth of 400-800 m, but there are 35 mines in Donbas that extract coal from the 1000-1300 m level. Coal-beds of Donetsk basin are interleaved with rock and are usually located every 20-40 m. Field development under such conditions result in vast amounts of rock being extracted and brought to the surface. Coal is separated from other rock matter, which are then dumped into huge waste heaps, found almost everywhere in Donbas. The process of separating coal at mines historically had low and sometimes very low efficiency. Also for a long time extracting 100% of coal from that rock, which was raised on the surface, was considered economically inexpedient. As a result of this, Donbas waste heaps contain large amounts of coal. Over time, waste heaps, containing coal, are very vulnerable to self-ignition and slow burning. According to various estimates, rock, extracted from mine, contains up to 65-70% of the coal, the rest is barren rock. Up to 60% of this rock goes to heaps. According to the results of research conducted by specialists, the share of combustible materials in heaps amounts to 15-30%, while from 7% to 28-32% of these materials is coal¹. Influenced by heaps, ground waters are being polluted with solid particles, increasing their acidity and hardness. Erosion processes, which often lead to the destruction of heaps, are the cause of contamination of the surrounding area by rock particles that contain hazardous materials (such as sulphur). Over time erosion may lead to the complete destruction of the heap and its transformation into massive landslide that is dangerous both in terms of direct threat to the population and property, and in terms of significant emissions of particulate matter and hazardous substances into the atmosphere. Erosion also contributes to the intensification of the process of spontaneous ignition. Burning coal in heaps is quite lengthy and may occur during the period of 5 to 7 years. Despite the danger, caused by burning waste heaps, immediate quenching heaps is not a common practice in Donbas. Owners, responsible for waste heaps, are obliged to pay relatively small fines for environmental pollution. Thus there is no weighty stimulus for them in solving this issue, and quenching burning heaps may be postponed for an indefinite term.

The purpose of the proposed project:

Purpose of the proposed project is dismantling and processing waste heaps by extracting thermal coal from carbonaceous rock, thus avoiding carbon dioxide emissions into the atmosphere from burning carbon component. The project is ecological and is aimed at improving the environmental situation in the region by preventing self-heating and self-ignition of waste heaps, formed by coal mines.

¹ *Geology of Coal Fires: Case Studies from Around the World*, Glenn B. Stracher, Geological Society of America, 2007, c. 47

This template shall not be altered. It shall be completed without modifying/adding headings or logo, format or font.

**Situation before the proposed project start:**

Waste heaps, formed by the coal mines, inclined to spontaneous combustion because of the presence of the coal fraction in them. As a result of physical and chemical processes in the middle of the waste heaps burning of coal-containing fractions and other combustible components occurs, leading to fugitive greenhouse gas emissions and other harmful pollutants in the environment. Measures on extinguishing the waste heaps are not regularly conducted, so the probability of spontaneous combustion is very high. Oxidation process of combustible elements in the waste heaps is slow and unpredictable, because it is difficult to identify centres of burning and eliminate them. Implementation of certain measures on extracting coal from the waste heaps are quite costly and are not possible without additional incentives. Legislation of Ukraine does not oblige owners of the waste heaps to monitor fire condition of these objects and liquidation of centres of spontaneous combustion.

Baseline scenario:

Baseline scenario assumes that the problem of waste heaps combustion will not be effectively resolved, carbonaceous rock of waste heaps will undergo self-ignition and burn until all volume of coal contained in it does not burn. Continuation of existing situation will lead to large emissions of greenhouse gases in the atmosphere and to the general pollution of the ecosystem of the region. In addition, the baseline scenario assumes coal extraction by mining method that leads to fugitive methane emissions during extraction and carbon dioxide emissions for electricity consumption from the power grid of Ukraine.

Project scenario:

This JI project is implemented on the territory of settlement Verhnyoherasymivska Village Council, Krasnodonskiy District of Lugansk region of Ukraine. Project boundaries include waste heaps #1, #2, #3, formed by the mine “Krasnodarska”, and also enrichment complex, located close to the waste heap #1.

The project “Carbonaceous rock processing and concentrating with the aim of reducing greenhouse gas emissions into the atmosphere” involves the introduction of complex of measures aimed at waste heaps dismantling with the aim of black coal extraction, which will partially replace coal that would otherwise be extracted by mining method, which would in turn lead to fugitive emissions of methane and carbon dioxide by electricity consumption.

Brief information on the history of the project and the role of JI:

The decision on the implementation of this project was taken on March 10, 2008. During 2009 agreement with company-contractor, who will provide transportation services, was signed, and lease agreement of concentrating mill and contract on recultivation of the waste heaps were concluded. Starting date of the project is March 10, 2008, when an order on implementation of this project using Joint Implementation Mechanism under the Kyoto Protocol was signed. Because of the fact that the proposed project is very expensive, the only incentive for the implementation of these actions was JI mechanism, which allows selling emission reduction units (ERUs) generated as a result of the project activity, at the International emissions trading market.

**A.3. Project participants:**

<u>Party involved</u>	<u>Legal entity project participant</u> (as applicable)	Please indicate if the <u>Party involved</u> wishes to be considered as <u>project participant</u> (Yes/No)
Ukraine (Host party)	“AGS-2008” LLC	No
Estonia	ProEffect OÜ	No

Table 1 – Project participants

“AGS-2008” LLC is Host party of the project and project participant. “AGS-2008” LLC is the owner of the emission source, where realization of the joint implementation project is planned.

“AGS-2008” LLC is the initiator of the project and developer of project design document at the same time. This company specializes in waste heaps dismantling and implements JI project under the Kyoto Protocol.

“ProEffect OÜ” is a project participant and potential buyer of ERUs under the project. Detailed contact information is provided in Annex 1.

A.4. Technical description of the project:

Technical description of the project, as well as detailed information on the location of the project is given below in subsections from A.4.1. to A.4.3.

A.4.1. Location of the project:

Settlement Verhnyoherasymivska, Krasnodonskiy District, Lugansk region, Ukraine.

A.4.1.1. Host Party (ies):

Ukraine.

Ukraine is the Eastern European country that ratified the Kyoto Protocol to the Framework UN Convention on February 4, 2004, is included in the list of countries of Annex 1, and meets the requirements for participation in Joint Implementation projects.

A.4.1.2. Region/State/Province etc.:

Lugansk region.

A.4.1.3. City/Town/Community etc:

Settlement Verhnyoherasymivska.

A.4.1.4. Detail of physical location, including information allowing the unique identification of the project (maximum one page):

Figure 1 – Project location on the map of Ukraine

The project is located in the village Verhnyoherasymivka, located in Krasnodonskiy District, Lugansk region of Ukraine. It is included in the Verhnyoherasymivska Village Council. Population is 286 people (2001). It is situated on the right bank of the River Velyka Kamyanka (the Siversky Donets basin). Railway station Verhnyoherasymivka (on the line of Krasnodon - Lykha). Village Verhnyoherasymivka is located in the eastern part of Ukraine within 60 km from the regional centre of Lugansk and 890 km from the capital of Ukraine Kyiv.

Geographical coordinates of the concentrating complex: [+48° 31' 00.16", +39° 97' 70.97"](#)

Geographical coordinates of the waste heaps:

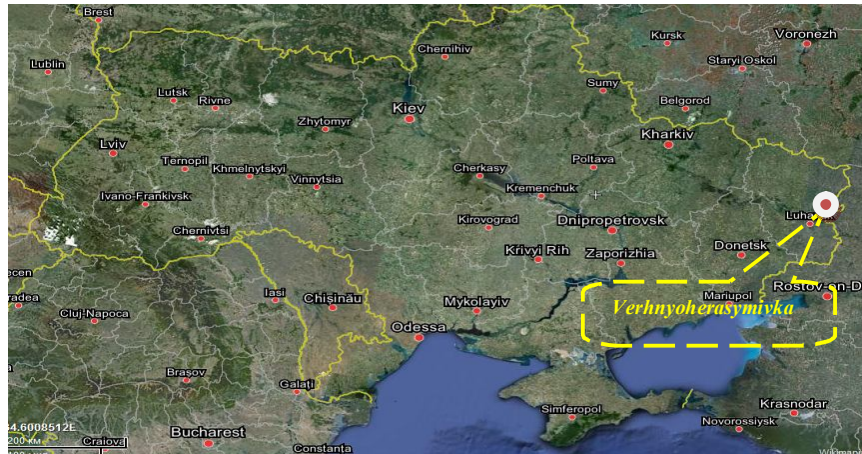
Waste heap #1: [+48° 31' 31.27", +98° 64' 79"](#)

Waste heap #2: [+48° 30' 50.07", +39° 98' 98.70"](#)

Waste heap #3: [+48° 30' 05.39", +39° 98' 72.30"](#)

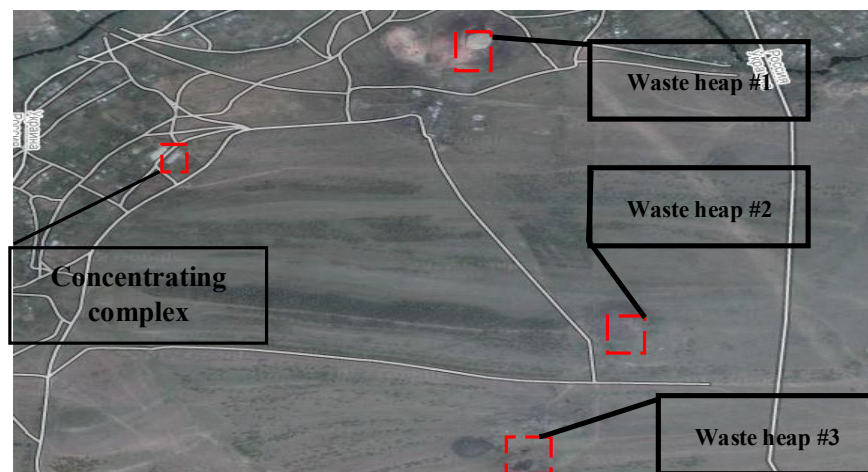

Figure 2 – Project objects location

**A.4.2. Technology(ies) to be employed, or measures, operations or actions to be implemented by the project:**

Technical component of the project allows producing high-quality coal products that will be used for the needs of the energy industry sector.

Installation for the enrichment with severe environment provides a very efficient separation process. It is perfect for complicated separation and purification of coal for domestic and industrial use. Overall, this process differs from other processes with use of water because it creates an environment using magnetite (fine particles of iron) instead of small particles in the raw material. This allows more efficient control of the process and increase of the separation range by the relative density.

The process of processing and enrichment of coal containing rock is held in several stages:

1. Waste heaps dismantling layer by layer (the work of bulldozers and excavators);
2. Transportation of the rock mass to the processing complex;
3. Acceptance of coal containing rock in a special bunker with a capacity of 40 tons (load is carried out by the scraper conveyor);
4. Classification of raw materials by 0-50 mm class;
5. Shipment of rock of +50 mm size in waste.
6. Transportation of coal containing fraction to the installation of wet classification by 1-50 mm class;
7. Submission of coal containing material to enrichment in difficult environmental hydro cyclone – separation of 0-50 mm class into coal concentrate and enrichment waste;
8. Suspension washing off with concentrate on two screens with the release of 1-13 mm and 13-50 mm classes – this product is for shipped to the consumer;
9. Additional dehydration of 1-13 mm class in centrifuge and further shipment of dewatered concentrate to the consumer;
10. Suspension washing off, dehydration of waste on three screens and their shipment;
11. Regeneration of suspension on drum magnetic separators in two stages with obtaining magnetite concentrate, discharge of clarified water and sludge water;
12. Thickening of sludge in thickeners with flocculation;
13. Dehydration of condensed sludge at screen with high frequency;
14. Return of magnetite to difficult environmental hydro cyclones.

Waste heaps are dismantled by usual equipment: bulldozers, excavators and trucks. Bulldozers form heaps of coal containing material, and excavators load this material into trucks. Further, this raw material is

This template shall not be altered. It shall be completed without modifying/adding headings or logo, format or font.

transported to the concentrating complex. From there, trucks return loaded by enrichment waste (empty weight) that are formed by bulldozers into piles of inertial mass. General scheme of all technological links under the project are presented in the figure below:

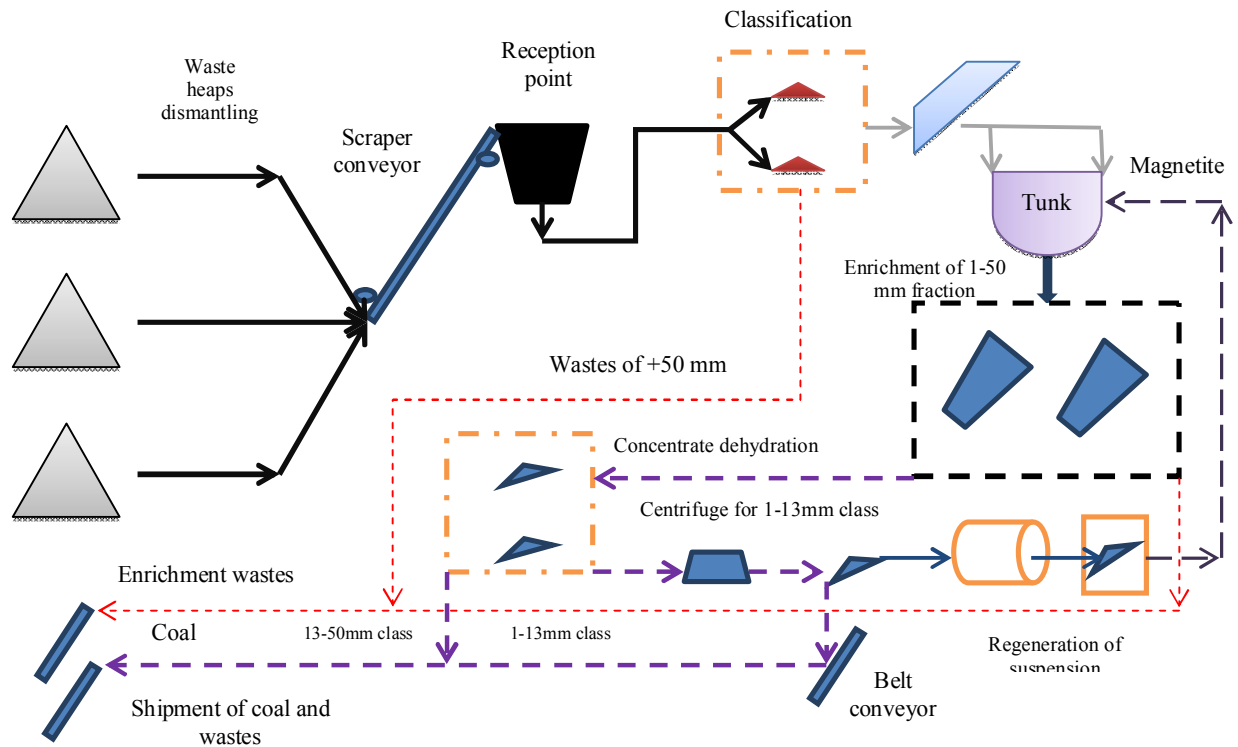

Figure 3 – General flowsheet of the process of carbonaceous rock enrichment

Thus, the concentrating complex includes the following equipment:

- 1) Scraper conveyor;
- 2) Bunker of rock reception of capacity 40t;
- 3) Classifical installations: vibrating screens VS-1237;
- 4) Moisturising vibrosieve;
- 5) Suspension tank BS-30;
- 6) Hydrocyclones with heavy environment GT-500;
- 7) Guiding gutters;
- 8) Dewatering screens GYST-41;
- 9) Centrifuge FGV-1321 VTM;
- 10) Dewatering vibrosieve;
- 11) Magnetic separator SKVP-20;
- 12) High-frequency screen GVD.

Under the project approximately 17 kW of electricity is consumed per 1 ton of coal produced. Load and consumption of electricity by the project equipment depends on production volume and characteristics of concentrating raw materials.

This template shall not be altered. It shall be completed without modifying/adding headings or logo, format or font.



The main element of concentrating complex is two heavy environment hydrocyclones GT-500 - heavy environment two-product hydrocyclones intended for coal enrichment in heavy environments. The device has cylindrical and conical form, equipped with tangential feeding pipe, sand nozzle and downspout, located on the same axis. Tangent entering source material mixed with heavy environment provides effective separation of coal into two final products: concentrate and waste. Magnetite slurry is used as separating medium. Hydrocyclones lined with wearproof surface: all working surfaces are protected by details from monolithic polycrystalline silicon carbide. This construction provides long operation of hydrocyclone without repair with preservation of the main parameters and geometric forms of the device.

Specifications of heavy environment hydrocyclone are presented in the table below:

Basic parameters	Value
Productivity:	
- on coal, t/h	50
- on source material, t/h	200
Fineness of concentrating material, mm	0,5 – 50
Slurry pressure at the inlet of feeding tube, MPa, not less	0,1
Overall dimensions, mm	2681x950x2153
Weight, kg	1090

Table 2 – Specifications of heavy environment hydrocyclone GT-500

According to the project two hydro cyclones are installed: one is the main and the other is backup. In the summer season of the year two units work when processing intensity falls – just one. Cyclones with severe environment are used for very accurate separation of particles with different density. Working suspension that circulated in the hydro cyclone is a mixture of raw materials (coal containing rock), water and magnetite, which allows very precise control of the density of environment. Cyclone with severe environment is installed with a certain angle of inclination. Lighter particles (coal) rise to the top edge, and heavier (rock) are removed to the bottom of the cyclone.

In cyclones small particles are separated by centrifugal and vortex action (cyclone thus remains stationary). A mixture of water/rock/magnetite is pumped from the side of cyclone in the tangential direction and is twisted in the generated vortex in which material that has less weight (density) is thrown through the central tube of cyclone to the chamber of release. Heavier particles are moved by centrifugal force to the walls of the cyclone and are discharged from the opposite end.

Installation of enrichment with heavy environment can effectively divide raw materials in wide range of correlations of mix elements. Additional benefits are: low energy consumption, high efficiency, low consumption of magnetite, reliable modular design, which provides quick installation and ease of moving. View of heavy environment hydrocyclone is presented below:

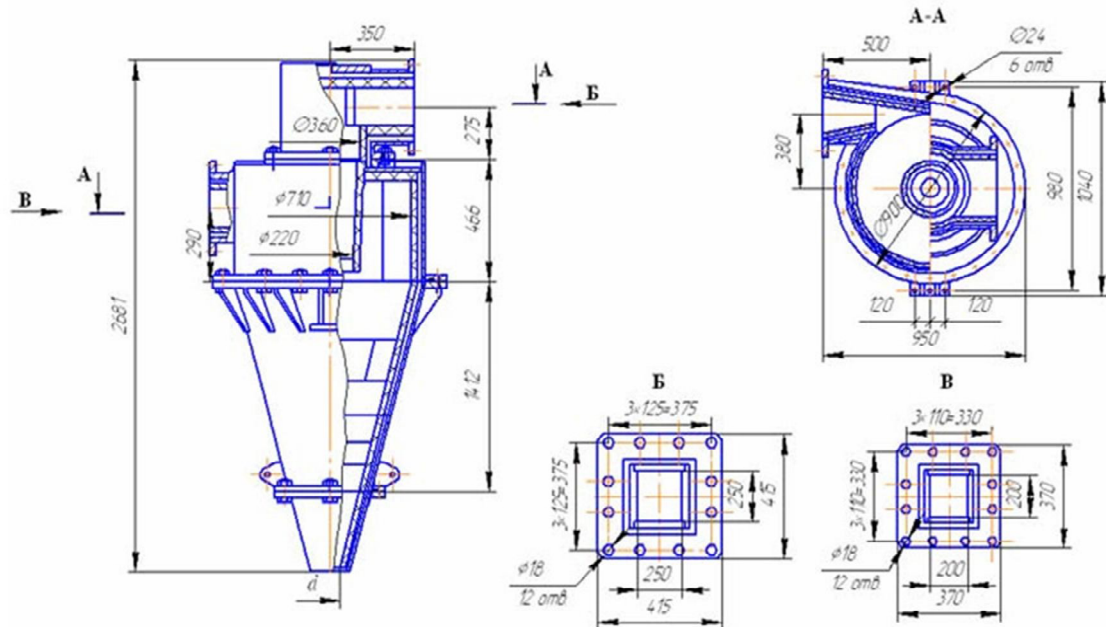

Figure 4 – Overall dimensions and connecting nodes of hydrocyclone GT-500

General view of hydrocyclone GT-500 is presented in the figure below:



Figure 5 – General view of hydrocyclone GT-500

An important step in the enrichment process of coal containing rock is dehydration of concentrate and clarification of process water and sludge capturing in mud settling pits. These processes take place using dewatering screens, centrifuges, magnetic separator and reservoirs for sludge.

Concentrating complex has nominal annual production capacity of 1100 thousand tons of coal containing rock on the basis of the next one mode of the heavy environmental hydrocyclone:

- Number of working days in a year, days – 300;

This template shall not be altered. It shall be completed without modifying/adding headings or logo, format or font.



- Number of shifts per day – 2;
- Duration of work per day, per hour – 8;
- Time efficiency, t/h – 230;
- Daily efficiency, t/day – 3600;
- Monthly efficiency, t/month – 90000.

Nominal capacity of two difficult environmental hydro cyclones amount to 180 000 t/month.

Special technique, and also building of enrichment complex, used under the project, is presented in the figure below:



Figure 6 – Technique used for dismantling waste heaps under the project and technological premises where concentrating equipment is installed

Waste heaps, dismantled as result of project activity, are presented in the figure below:



a)

b)



c)

Figure 7 – a) Waste heap #1; b) Waste heap #2; c) Waste heap #3.

As a result of this JI project ROM coal of energy class will be extracted that will partially replace coal that would be mined in the coal mines otherwise End product is low-ash concentrate of 1-50 mm size. The proposed measures allow reaching the output of the final product at 19% level. Enrichment wastes are formed in the new flat heaps that have no tendency to spontaneous combustion. Impact of the proposed project on the environment is expected within the permitted maximum allowable concentrations. The project has a positive impact on waste formation, as it implies dismantling and utilization of coal production wastes. Percentage of coal in 50 mm fraction after concentrating installation is low because of modern technology of coal and rock separation. This parameter is not specifically controlled, but using technology its safe value is provided. +50 mm fraction is inertial mass which is waste of the main production in this project and is aimed at recultivation and formation of new flat heap, whose state is controlled.

As a result of implementation of this JI project ROM coal of thermal class will be extracted, which will partly replace the coal, which would be extracted in the coal mines. Enrichment wastes are formed in the new flat heaps that have no tendency to spontaneous combustion because of the low coal concentration in them, as enrichment waste is inert mass. Technology that is being implemented by the projects a modern reflection of engineering solutions in matters of wet concentration of rock mass of waste heaps. Impact of the proposed project on the environment is expected within the permitted maximum allowable concentrations. The project has a positive impact on waste formation, as it implies dismantling and utilization of coal production wastes.

Most part of the equipment within this project, such as trucks, excavators, bulldozers refers to the standard type of industrial equipment used worldwide.

Decision on implementation of this project was taken on March 10, 2008 according to the order No.65 dated 10/03/2008. Date of signing this document is the starting date of the project. “AGS-2008” LLC, basing on the concluded with the customer contract No.118/04-2009 dated 18/04/2009 commits itself to perform works on technical mining recultivation of the waste heaps #1,2,3, located on the territory of settlement

This template shall not be altered. It shall be completed without modifying/adding headings or logo, format or font.



Verhnyoherasymivka, Krasnodonskiy District, Lugansk region, Ukraine. “AGS-2008-2008” LLC rents enrichment complex that belongs to “ENERGOCEMENT”, basing on the concluded with the customer contract №115/05-2009 dated 15/05/2009. For performing works on dismantling the waste heap and transportation of rock mass to enrichment complex JI project owner entered into agreement with the company-contractor of “SMU” LLC №119/05-2009 dated 19/05/2009, which will implement these works. “AGS-2008-2008” LLC is the JI project owner and developer of the project design documentation simultaneously.

Stages of the project activity implementation are given in the table below:

Activity	Actual date
Date of decision taking on JI project implementation	10/03/2008
Beginning of the investment phase	18/04/2009
Commissioning works	15/05/2009
End of the investment phase	19/05/2009
Start of operation of concentrating mill	01/06/2009

Table 3 – Stages of project activity implementation

The project does not require intensive pre-training. Required number of staff can receive basic training on the project site. Most workers, such as operators of heavy equipment, truck and excavators drivers, mechanics and electricians work on the project site. Project needs in technical maintenance are met by local resources: own employees for internal maintenance and contractors for repair. The project provides training. All employees must have valid professional certificates, to undergo periodically safety training and pass exams.

Important stage of this project is also recultivation of lands that were occupied by waste heaps, and their return to community. Waste from beneficiation complex (empty rock) can be used in the construction of roads and for formation of the territory of abandoned open developments and pits in order to reuse these sites. This part of the project is obligatory but totally expensive, because of this joint implementation mechanism was one of the prominent factors of the project from the very beginning, and financial benefits under this mechanism were considered as one of the reasons of project beginning.

A.4.3. Brief explanation of how the anthropogenic emissions of greenhouse gases by sources are to be reduced by the proposed JI project, including why the emission reductions would not occur in the absence of the proposed project, taking into account national and/or sectoral policies and circumstances:

The problem of waste heaps is very relevant now in Donbas. Waste heaps do not only eliminate large areas of land from economic circulation and lead to disruption of the ecological balance of the natural ecological community, but also are a source of increased environmental hazards. Even in a non-burning state the waste heap is a source of pollution of atmosphere, soil, adjacent waters and groundwater. This danger is increased many times by burning of the waste heap².

The proposed project involves complex of measures aimed at the recultivation of the waste heaps for extracting black coal from them. These measures will allow reducing GHG emissions from burning coal and

² http://terrikon.donbass.name/ter_s/290-model-samovozgoraniya-porodnyx-otvalov-ugolnyx-shaxt-donbassa.html

This template shall not be altered. It shall be completed without modifying/adding headings or logo, format or font.



rock mass and will also allow receiving additional amount of coal that will partially replace coal, which is extracted in coal mines. Besides, implementation of the project activity will allow reducing fugitive methane and carbon dioxide emissions from electricity consumption from the grid during operation of coal mines. Prerequisite for such measures implementation is that waste heaps are often inclined to self-heating and subsequent burning, causing emissions of hazardous substances and greenhouse gases. The part of coal in the waste heaps can be as high as 28-32%, so the risk of spontaneous self-heating and burning is very high³. The survey shows⁴, 78% of waste heaps in the Lugansk region are, or have been burning. If a waste heap has started burning, even if the fire is extinguished, it will continue burning after a while unless the fire is extinguished regularly. Burning waste heaps in Ukraine are very often not taken care of properly, especially when there is no immediate danger to population and property, i.e. if the waste heap is located at a considerable distance from a populated area, or is at the early stages of self-heating. The only way to prevent burning heap is extraction of all combustible matter, which are in residual coal after extraction process in coal mines.

Coal extracted from the waste heap will replace coal, which is extracted by mining method, and will be used to generate electricity at TPPs. Coal of the anthracite group will be extracted under the project.

Emission reductions resulting from this project will come from three main sources:

- Elimination of carbon dioxide emissions sources from combustion of waste heap by extraction of thermal coal from it;
- Reduction of the fugitive methane emissions volume related to coal mining by substitution of amount of such coal to the coal that is produced from the waste heaps as a result of the project activity;
- Reducing electricity consumption from the grid during recultivation of the waste heaps in comparison with energy consumption during coal production in the mine.

The process of waste heaps recultivation is very expensive, the investment effect of which is lower than capital investment. There are also many other negative factors in realization of such measures, such as uncertainty of early coal content in the total rock mass, instability of sales market of coal production in Ukraine. Besides, Ukraine does not resolve this issue on a systematic basis. Efforts to stop waste heaps burning and their full dismantling, corresponds the current Legislation of Ukraine on Environmental Protection. Proposed project is positively estimated by local authorities.

Detailed description of the baseline and full analysis of additionality are given in Section B of PDD.

A.4.3.1.	Estimated amount of emission reductions over the <u>crediting period</u>:
-----------------	----------------------------------------------------------------------------------

	Years
Length of the <u>crediting period</u>	4
Year	Estimated annual emission reductions in tonnes of CO ₂ equivalent
Year 2009	298 325
Year 2010	562 798
Year 2011	599 648
Year 2012	585 710
Total estimated emission reductions over the <u>crediting period</u>	2 046 481

³ *Geology of Coal Fires: Case Studies from Around the World*, Glenn B. Stracher, Geological Society of America, 2007, p. 47

⁴ *Report on the fire risk of Lugansk Region's waste heaps*, Scientific Research Institute "Respirator", Donetsk, 2012.

This template shall not be altered. It shall be completed without modifying/adding headings or logo, format or font.



(tonnes of CO ₂ equivalent)	
Annual average estimated emission reductions over the crediting period (tonnes of CO ₂ equivalent)	571 111

Table 4 – Estimated amount of emission reductions over the crediting period

	Years
Length of the period after 2012, for which achieved emission reductions are calculated	1
Year	Estimated annual emission reductions in tonnes of CO ₂ equivalent
Year 2013	468 298
Total estimated emission reductions after the crediting period (tonnes of CO ₂ equivalent)	468 298
Annual average estimated emission reductions after the crediting period (tonnes of CO ₂ equivalent)	468 298

Table 5 – Estimated amount of emission reductions after the crediting period

A.5. Project approval by the Parties involved:

Letter of Endorsement No. 3655/23/7 dated 28/11/2012 was issued by State Environment Investment Agency of Ukraine. According to the national Ukrainian procedure Letter of Approval from Ukraine is expected after determination of the project. Letter of Approval from Estonia is expected after determination of the project.

**SECTION B. Baseline****B.1. Description and justification of the baseline chosen:**

A baseline for the JI project has to be set in accordance with Appendix B to decision 9/CMP.1 (JI guidelines)⁵, and with further guidance on baseline setting and monitoring developed by the Joint Implementation Supervisory Committee (JISC). In accordance with the Guidance on Criteria for Baseline Setting and Monitoring (version 3)⁶ (hereinafter referred to as Guidance), the baseline for a JI project is the scenario that reasonably represents the anthropogenic emissions by sources or anthropogenic removals by sinks of GHGs that would occur in the absence of the proposed project.

In accordance with the Paragraph 9(a) of the Guidance the project participants may select either: an approach for baseline setting and monitoring developed in accordance with appendix B of the JI guidelines (JI specific approach); or a methodology for baseline setting and monitoring approved by the Executive Board of the clean development mechanism (CDM), including methodologies for small-scale project activities, as appropriate, in accordance with paragraph 4(a) of decision 10/CMP.1, as well as methodologies for afforestation/reforestation project activities. Paragraph 11 of the Guidance allows project participants that select a JI specific approach to use selected elements or combinations of approved CDM baseline and monitoring methodologies or approved CDM methodological tools, as appropriate; or, if necessary, approved CDM methodologies or methodological tools.

The baseline will then include description and justification in accordance with the “Guidelines for users of the Joint Implementation Project Design Document Form”, version 04⁷, using the following step-wise approach:

Step 1: Identification and description of the theoretical approach chosen to establish the baseline

Project participants have chosen the following approach regarding baseline setting, defined in the Guidance (Paragraph 9a):

- An approach for baseline setting and monitoring already taken in comparable JI cases (JI specific approach).

The Guidance applies to this project as the above indicated approach is selected as mentioned in the Paragraph 12 of the Guidance. The detailed theoretical description of the baseline in a complete and transparent manner, as well as a justification in accordance with Paragraph 23 through 29 of the Guidance should be provided by the project participants.

The baseline for this project should be established in accordance with Annex B JI guidelines. In addition, the baseline should be determined by listing and describing the possible future scenarios based on conservative assumptions and choice most plausible from them. Taking into account JI special approach selected for determining the baseline, in accordance with Article 24 of JISC Guidelines, baseline is identified by listing and describing possible future scenarios based on conservative assumptions and choosing one of the most possible.

To determine the most possible future scenario barrier analysis was used.

After analyzing all variants development of the baseline, two scenarios were identified, one of which reflected the project scenario with JI mechanism. To demonstrate additionality of the project clear and transparent information was provided about similarity of approach of additionality demonstration, it was used

⁵ <http://unfccc.int/resource/docs/2005/cmp1/eng/08a02.pdf#page=2>

⁶ http://ji.unfccc.int/Ref/Documents/Baseline_setting_and_monitoring.pdf

⁷ <http://ji.unfccc.int/Ref/Documents/Guidelines.pdf>



in those cases where the final determination of the project was held, with the help of which comparative analysis can be performed.

Description of the possible future scenarios of the baseline is based on the following key factors:

- policies and legislation, directed to reforming of this sector of industry;
- economic situation in the country and socio-demographic factors in the relevant sectors;
- stability of demand on coal market;
- investment;
- fuel prices and its availability;
- national and/or subnational expansion plans for the energy sector.

Step 2. Application of the approach chosen

Plausible future scenarios will be identified in order to establish a baseline.

Sub step 2a. Identifying and listing plausible future scenarios.

Scenario 1. Continuation of the existing situation

Nowadays waste heaps are not utilized. Self-ignition and subsequent burning of waste heaps is common practice, and extinguishing measures are performed from time to time. Burning of heaps leads to fugitive greenhouse gas emissions. Coal is not extracted from the waste heaps but extracted in the mines of the region and used for energy production or other purposes. Coal extraction causes fugitive methane emissions, and contributes to the emergence of new waste heaps.

Scenario 2. Implementation of measures on the use of thermal energy of the waste heap, which burns, for energy generation

In certain circumstances burning waste heaps are not extinguished and their condition is not monitored properly. In some cases, for the use of thermal energy of the waste heaps⁸ special heat exchangers of stationary type are used, that have direct contact with centre of rock mass combustion. Thus, received thermal energy can be used to generate electricity and heat. However, this approach does not exclude greenhouse gas emissions into the atmosphere by burning of the waste heaps. Coal will continue to be produced by underground mines and used for energy sectors purposes. Mining activities result in fugitive gas release, and the formation of more waste heaps.

Scenario 3. Production of construction materials on the basis of raw materials from waste heaps

Waste heaps are being processed in order to produce construction materials (bricks, panels, etc.). Coal in the waste heap matter is burnt during the agglomeration process⁹. Coal is produced by underground mines of the region and used for energy production or other purposes. Mining activities result in fugitive gas release, and the formation of more waste heaps.

⁸ *Method to utilize energy of the burning waste heaps*, Melnikov S.A., Zhukov Y.P., Gavrilenko B.V., Shulga A.Y., State Committee Of Ukraine For Energy Saving, 2004.

(<http://www.masters.donntu.edu.ua/2004/fgtu/zayanchukovskaya/library/artcl3.htm>)

⁹ *Opportunities for international best practice use in coal mining waste heap utilization of Donbas*, Matveeva N.G., Ecology: Collection of Scientific Papers, Eastern Ukrainian National University, Lugansk, #1 2007.

http://www.nbu.gov.ua/portal/natural/Ecology/2007_1/Article_09.pdf

This template shall not be altered. It shall be completed without modifying/adding headings or logo, format or font.

***Scenario 4. Coal extraction from waste heaps without incentives of JI mechanism***

Situation under this scenario is identical to the project scenario only, the project itself does not benefit from the terms of implementation of JI project. Waste heaps are processed in order to extract coal and use it in the energy complex of industry, due to this less coal is produced by underground mines of the region.

Scenario 5. Systematic monitoring of waste heaps condition, regular fire prevention and application of extinguishing measures

Waste heaps are systematically monitored and its thermal condition is observed. Regular fire prevention measures are taken. In case of burning of waste heap fire is extinguished and measures to prevent burning in the future are held. In this case coal extracted from the waste heaps is not used for energy production, and the whole amount of coal is produced by underground mines that result in fugitive methane release and formation of more waste heaps.

Sub step 2b. Barrier analysis***Scenario 1. Continuation of existing situation***

This scenario requires the implementation of no measures, so there are no barriers.

Scenario 2. Implementation of measures on the use of thermal energy of the waste heap that burns for energy generation

Technological barrier: This scenario is based on an experimental technology that has not yet been used. This approach is not suitable for all waste heaps, as the project owner will have to balance the availability of energy resources (i.e. waste heap location) and location of the energy consumer. Electricity production at the site addresses this issue, but requires additional capacity connections. Generally, it is also need to prove the feasibility of this technology. Besides it does not allow monitoring and controlling the emission of gases. The proposed technology can be applied only in the presence of waste heap with advanced combustion unit. Even if the probability of waste heap ignition is very high, it is currently impossible to predict the time of its outbreak and therefore to predict the start of thermal energy use released during its combustion.

Investment barrier: Considering the fact that this technology is in its initial phase of the experiment, investment into this project results in a high risk besides Ukraine is ranked as a high-risk country¹⁰. Investments into such kind of unproven energy projects unlikely to attract investors more than some other investment opportunities into energy industry with higher profitability. The pioneering character of the project may interest programmes of technical support and governmental incentives, but the cost of the produced energy is likely to be much higher than that of the alternatives.

Scenario 3. Production of construction materials on the basis of raw materials from waste heaps

Technological barrier: This scenario is based on known technology, which, however, is not currently available in Ukraine and there is no evidence that such projects will be implemented in the near future. It is also not suitable for all types of waste heaps as composition of the waste heap has to be predictable in order

¹⁰ AMB Country Risk Report: Ukraine October 29, 2010 <http://www3.ambest.com/ratings/cr/reports/Ukraine.pdf>

This template shall not be altered. It shall be completed without modifying/adding headings or logo, format or font.



for project owner to be able to produce quality materials¹¹. High content of sulphur and moisture can reduce the suitability of the waste heap for processing. A large-scale and detailed exploration of the waste heap has to be performed prior to the start of the project. Pilot projects of this type are implemented only with the support of public funding¹².

Investment barrier: Taking into account the fact that introduction of this technology faces many risks and technological barriers; investment attractiveness of this scenario is very low. Condition of the waste heaps is not controlled by the State, and the owners of the heaps often neglect measures on their monitoring. It is not profitable for private entities to produce construction materials by recycling rock mass, because the level of uncertainty is very large. This scenario is only possible under available financial support from the State, which currently does not make any prerequisites, what is possible.

Scenario 4. Coal extraction from waste heaps without incentives of JI mechanism

Investment barrier: This scenario is financially unattractive and faces barriers. Please refer to Section B.2. for details.

Scenario 5. Systematic monitoring of waste heaps condition, regular fire prevention and application of extinguishing measures

Technological barrier: This scenario does not include any income, but involves additional costs for the owners of the waste heaps. Monitoring of the state of waste heaps is not performed systematically, and all activities are left at the discretion of the owner of the heaps. Basically waste heaps belong to mines or regional associations of mining. Coal mines of Ukraine suffer from limited investment that often causes problems of danger because of poor conditions of extraction and financial difficulties, besides salary of miners is often delayed for several months. In this case, the waste heaps are considered as an additional burden, and mine usually do not make even minimum required measures. Self-ignition and burning of heaps are common practice. Exact statistics are not always available. From a commercial point of view fines, which are usually issued by governments, are lower than the cost of necessary measures highlighted in this project.

Investment barrier: This scenario does not represent any revenues but anticipates additional costs for waste heaps owners. Monitoring of the waste heap status is not carried out systematically and actions are left to the discretion of the individual owner of the waste heaps. Mainly waste heaps belong to mines or regional coal mining associations. Coal mines in Ukraine suffer from limited funding resulting in safety problems due to complicated mining conditions and financial constraints with miners' salaries often being delayed by few months. In this case waste heaps are considered as an additional burden, and mines usually do not make even minimum measures required. Self-heating and burning of heaps are common practice. Exact statistics are not always available. From a commercial view point the fines that are usually levied by the authorities are considerably lower than the costs of all the measures outlined in this project.

¹¹ *Opportunities for international best practice use in coal mining waste heap utilization of Donbas*, Matveeva N.G., Ecology: Collection of Scientific Papers, Eastern Ukrainian National University, Lugansk, No.1 2007.

http://www.nbu.gov.ua/portal/natural/Ecology/2007_1/Article_09.pdf

¹² <http://www.rostovstroy.ru/archive/articles/1164.html>

This template shall not be altered. It shall be completed without modifying/adding headings or logo, format or font.



Sub step 2d. Baseline identification

All scenarios, except Scenario 1 – Continuation of the existing situation, face prohibitive barriers. Therefore, continuation of the existing situation is the most plausible future scenario and is the baseline scenario.

In accordance with the laws and legal norms of Ukraine waste heaps are the source of possible dangerous emissions into the atmosphere. Measures on extinguishing and monitoring of fire-hazardous waste heaps are regulated by “Mine Safety Rules”¹³. In practice, the legal use of this document is not significant because in certain cases These measures are regulated by Code of Ukraine on Administrative Violations that in Article 41 provides maximum penalty for such violation¹⁴ only 10 non-taxable minimum incomes, i.e. subsistence level according to Tax Code (Section 1, Article XX section 5 and section IV of article 169.1.1)^{15,16, 17} and is 1044 UAH as of ¹⁸ July 1, 2012. Thus, the maximum penalty is 10 440 UAH (1004 Euros), that is small amount for the company. However, because of the big number of waste heaps and their large sizes, coupled with the limited resources of the owners, they usually do not make even the minimum required monitoring. In case of self-heating of the waste heap, the owners of these objects typically do not apply any measures to extinguish the fire centres, and only pay small penalties for environmental pollution by combustion products. Under such circumstances it is clear that the baseline scenario does not contradict valid laws and legal norms, taking into account their performance in Ukraine.

This baseline scenario has been established according to the criteria outlined in the JISC Guidance:

- On a project specific basis.
- In a transparent manner with regard to the choice of approaches, assumptions, methodologies, parameters, data sources and key factors. All parameters and data are either monitored by the project participants or are taken from sources that provide a verifiable reference for each parameter. Project participants use approaches suggested by the Guidance and methodological tools provided by the CDM Executive Board;
- Taking into account relevant national and/or sectoral policies and circumstances, local fuel availability, power sector expansion plans, and the economic situation in the coal sector. The above analysis demonstrates that the baseline chosen clearly represents the most probable future scenario taking into account the circumstances of the situation of Donbas coal sector for today;
- In such a way that emission reduction units (ERUs) cannot be earned for decreases in activity levels outside the project activity or due to force majeure. According to the proposed approach the emission reductions will be earned only when project activity generate coal from the waste heaps, so no emission reductions can be earned due to any changes outside of project activity.
- Taking into account the uncertainties and using conservative assumptions. A number of steps have been taken in order to account for uncertainties and safeguard conservativeness:

¹³ Chapter IX, Article 7, NPAOP 10.0-1.01-10 Mine Safety Rules. Order No.62 State Committee of Ukraine on industrial security, labour protection and mining supervision – 22.03.2010 <http://zakon1.rada.gov.ua/cgi-bin/laws/main.cgi?nreg=z0398-10>

¹⁴ Article 41 of the Code of Ukraine on Administrative Violations – <http://zakon1.rada.gov.ua/cgi-bin/laws/main.cgi?page=2&nreg=80731-10>

¹⁵ <http://www.profiwins.com.ua/uk/legislation/kodeks/1368.html>

¹⁶ <http://www.profiwins.com.ua/uk/legislation/kodeks/1350.html>

¹⁷ <http://jurisconsult.net.ua/spravochniki/382-rozmir-minimalnoyi-zarobitnoyi-plati-z.html>

¹⁸ <http://minfin.com.ua/buh/minimum/>



1. If possible, the same approaches are used to calculate baseline and project emissions when possible, that are in the National Inventory Reports (NIRs) of Ukraine. NIRs use country specific approaches and country specific emission factors that are in line with default IPCC values;
2. Default values were used to the extent possible in order to reduce uncertainty and provide conservative data for emission calculations.

Baseline Emissions:

For baseline emissions calculation, following assumptions were made:

1. The project will produce thermal coal that will displace the same amount of the same type of coal in the baseline scenario;
2. The coal that is displaced in the baseline scenario and the coal that is generated in the project activity are used for the same type of purpose and is stationary combusted;
3. The coal that is displaced in the baseline scenario is produced by the underground mines of the region and as such causes fugitive emissions of methane;
4. For mining coal that is substituted in the baseline scenario, a significant amount of electricity from the energy grid of Ukraine is consumed which leads to greenhouse gas emissions;
5. Waste heaps of the region are vulnerable to spontaneous self-heating and burning and at some point in time will burn;
6. The waste heaps that will be dismantled during the project realization are categorized as being at risk of ignition. In other words, if they are not utilized, they will self-heat under normal circumstances;
7. The processed rock is not vulnerable to self-heating and spontaneous ignition after the coal has been removed during the processing;
8. The correction factor is applied in order to address the uncertainty of the waste heaps burning process. This factor is defined on the basis of the survey of all the waste heaps in the area that provides a ratio of waste heaps that are or have been burning at any point in time to all existing waste heaps;
9. The total amount of coal processed by the project will be burned in the heaps over the same period.

Baseline emissions come from two major sources:

1. Carbon dioxide emissions that occur during combustion of energy coal. These are calculated as stationary combustion emissions from coal in the equivalent of the amount of coal that is extracted from the waste heaps in the project scenario. This emission source is also present in the project scenario and the emissions are assumed to be equal in both project and baseline scenarios. Therefore, this emission source is not included into consideration both in the project and the baseline scenario.
2. Carbon dioxide emissions from burning waste heaps. These are calculated as stationary combustion emissions from coal in the equivalent of the amount of coal that is extracted from the waste heaps in the project scenario, adjusted by the probability of a waste heap burning at any point in time. As the baseline suggests that the current situation is preserved regarding the waste heaps burning and the waste heaps in question are at risk of burning, it is assumed that actual burning will occur. The correction factor is applied in order to address the uncertainty of the waste heaps burning process. This factor is defined on the basis of the survey of all the waste heaps in the area providing a ratio of waste heaps that are or have been burning at any point in time to all existing waste heaps.

The table below provides values for constant parameters used to determine the baseline emissions:

This template shall not be altered. It shall be completed without modifying/adding headings or logo, format or font.



<i>Data / Parameter</i>	<i>Data unit</i>	<i>Description</i>	<i>Data Source</i>	<i>Value</i>
P_{WHB}	dimensionless unit	Correction factor, determining the probability of spontaneous combustion of the waste heap	Report on the fire risk of Lugansk Region's waste heaps, Scientific Research Institute "Respirator", Donetsk, 2012	0.78
$NCV_{Coal,y}$	TJ/kt	Net calorific value of coal in year y	National Inventory Report of Ukraine ¹⁹ 1990-2010 p. 462, 468 (1.A.1.a – Public Electricity and Heat Production)	2009 – 21.8 2010 – 21.6 2011 – 21.6 2012 – 21.6
$OXID_{Coal,y}$	ratio	Carbon oxidation factor of coal in year y	National Inventory Report of Ukraine 1990-2010 p. 465, 471 (1.A.1.a – Public Electricity and Heat Production)	2009 – 0.963 2010 – 0.962 2011 – 0.962 2012 – 0.962
$k_{Coal,y}^C$	t C/TJ	Carbon content of coal in year y	National Inventory Report of Ukraine 1990-2010 p. 464, 470 (1.A.1.a – Public Electricity and Heat Production)	2009 – 25.97 2010 – 25.99 2011 – 25.99 2012 – 25.99
$A_{coal,y}$	%	Average ash content of thermal coal extracted in Luhansk region, Ukraine	Guide of quality, volume of coal production and enrichment products in 2008-2010, Ministry of Coal Industry of Ukraine, State Committee of Ukraine, and Lugansk 2010 (see Annex 4). Indicators for thermal coal.	2009 – 38.40 2010 – 38.10 2011 – 38.10 2012 – 38.10
$W_{coal,y}$	%	Average water content of thermal coal extracted in Luhansk region, Ukraine	Guide of quality, volume of coal production and enrichment products in 2008-2010, Ministry of Coal Industry of Ukraine, State Committee of Ukraine, Lugansk 2010 (see Annex 4). Indicators for thermal coal.	2009 – 7.4 2010 – 7.4 2011 – 7.4 2012 – 7.4

Table 6 – List of constants used in the calculations of baseline emissions

Calculation results are presented in metric tons of carbon dioxide equivalent (tCO₂e), 1 metric ton of carbon dioxide equivalent is equal to 1 metric ton of carbon dioxide (CO₂), i.e. 1 tCO₂e = 1 tCO₂.

Baseline emissions are calculated as follows:

$$BE_y = BE_{WHB,y} \quad (\text{Equation 1}),$$

¹⁹ http://unfccc.int/national_reports/annex_i_ghg_inventories/national_inventories_submissions/items/5888.php



where:

BE_y , - Baseline emissions in period y , tCO₂e,

$BE_{WHB,y}$ - Baseline emissions related to waste heaps combustion in period y , tCO₂e.

Baseline emissions related to waste heaps combustion are in turn calculated as:

$$BE_{WHB} = \frac{FC_{BE,Coal,y}}{1000} \cdot P_{WHB} \cdot NCV_{Coal,y} \cdot OXID_{Coal,y} \cdot k_{Coal,y}^C \cdot \frac{44}{12}, \quad (\text{Equation 2}),$$

where:

- $FC_{BE,Coal,y}$ - Amount of coal that would be mined in the baseline scenario and consumed in the energy sector for energy production in the relevant period y , t;
- P_{WHB} - Correction factor, determining the probability of spontaneous combustion of the waste heap, dimensionless unit;
- $NCV_{Coal,y}$ - Net calorific value of coal in period y , TJ/kt;
- $OXID_{Coal,y}$ - Carbon oxidation factor for coal in period y , relative unit;
- $k_{Coal,y}^C$ - Carbon content of coal in period y , t C/TJ;
- $\frac{44}{12}$ - Ration between molecular mass of CO₂ and C. Reflect oxidation of C to CO₂;
- $1/1000$ - Physical transformation [t] in [kt] for calculation purposes.

Amount of coal, mined in the baseline scenario and consumed in the energy sector for energy production, replaced by equivalent amount of coal, extracted from the waste heaps in the project scenario. Qualitative indicators of coal extracted in the coal mine and received as a result of recultivation of waste heaps may differ significantly. All coal-containing fractions consist of carbon, sulphur, water content (water) and ballast particle – ash, which does not burn. Indicators of ash and water content of coal in baseline and project scenarios should be brought to averaged characteristics for Ukraine. It should also be noted that the averaging characteristics of quality of Ukrainian coal is performed for all classes of coal, including lignite coal, which is not used for electricity production at TPPs. High quality coal concentrate will be produced under the project for the purposes of power engineering. In addition to moisture and ash coal (carbonaceous rock) also has sulphur, but its amount does not exceed few percent²⁰, its content in carbonaceous rock of waste heap always less, then in coal, extracted in the mines, therefore for calculating the amount of extracted in the mine coal, which is substituted by the coal extracted from the waste heaps, this indicator can be neglected. Amount of coal that would have been mined in the baseline scenario and combusted for energy production is calculated as follows:

$$FC_{BE,coal,y} = FR_{coal,y} \cdot \frac{\left(1 - \frac{A_{enrich,y}}{100} - \frac{W_{enrich,y}}{100}\right)}{\left(1 - \frac{A_{coal,y}}{100} - \frac{W_{coal,y}}{100}\right)} \quad (\text{Equation 3}),$$

²⁰ <http://masters.donntu.edu.ua/2009/feht/semkovskiy/library/article9.htm>

This template shall not be altered. It shall be completed without modifying/adding headings or logo, format or font.



where:

- $FR_{coal,y}$ - Amount of coal product, received by enrichment of carbonaceous rock as a result of project activity in the relevant period y ;
- $A_{enrich,y}$ - Average ash content of extracted from the waste heaps coal as a result of the project activity in period y , %;
- $W_{enrich,y}$ - Average water content of extracted from the waste heaps coal as a result of the project activity in period y , %;
- $A_{coal,y}$ - Average ash content of thermal coal extracted in Lugansk region of Ukraine in period y , %;
- $W_{coal,y}$ - Average water content of thermal coal extracted in Lugansk region of Ukraine in period y , %.

Key information and data used to establish the baseline are provided below in tabular form:

Data/Parameter	$FC_{BE,Coal,y}$
Data unit	t
Description	Amount of coal that would be mined in the baseline scenario and consumed in the energy sector for energy production in the relevant period y , t.
Time of <u>determination/monitoring</u>	Monthly
Source of data (to be) used	Project owner records
Value of data applied (for ex ante calculations/determinations)	As provided by the project owner
Justification of the choice of data or description of measurement methods and procedures (to be) applied	Calculated according to the equation (3), Section B.1.
QA/QC procedures (to be) applied	According to the internal rules of the project owner
Any comment	No

Table 7 – Amount of coal that would be mined in the baseline scenario

Data/Parameter	$FR_{Coal,y}$
Data unit	t
Description	Amount of coal product, received by enrichment of carbonaceous rock as a result of project activity in the relevant period y
Time of <u>determination/monitoring</u>	Monthly
Source of data (to be) used	Data of the company, based on the results of coal weighing on the scales.
Value of data applied (for ex ante calculations/determinations)	Provided by the project owner

This template shall not be altered. It shall be completed without modifying/adding headings or logo, format or font.



Justification of the choice of data or description of measurement methods and procedures (to be) applied	Measured for the commercial purposes on site
QA/QC procedures (to be) applied	In accordance with national standards
Any comment	No

Table 8 – Amount of coal product, received by enrichment of carbonaceous rock as a result of project activity

Data/Parameter	$A_{coal,PJ,y}$
Data unit	%
Description	Average ash content of extracted from waste heap coal as a result of the project activity in the period y
Time of <u>determination/monitoring</u>	Monitoring annually
Source of data (to be) used	Data of the company
Value of data applied (for ex ante calculations/determinations)	Project owner records
Justification of the choice of data or description of measurement methods and procedures (to be) applied	Laboratory studies
QA/QC procedures (to be) applied	According to national standards.
Any comment	If the data on the average ash content of sorted fraction and average water content of sorted fraction extracted from the heap in the period y are not available to the developer, or are irregular with the high level of uncertainty, they are taken equal to the corresponding nationwide indicators (reference book of quality indicators, amount of coal production and release of enrichment products, Ministry of Coal Industry of Ukraine, State Committee of Ukraine).

Table 9 – Average ash content of extracted from waste heap coal as a result of the project activity

Data/Parameter	$W_{coal,PJ,y}$
Data unit	%
Description	Average water content of extracted from waste heap coal as a result of the project activity in the period y
Time of <u>determination/monitoring</u>	Monitoring annually
Source of data (to be) used	Data of the company
Value of data applied (for ex ante calculations/determinations)	Project owner records
Justification of the choice of data or description of measurement methods and procedures (to be) applied	Laboratory studies

This template shall not be altered. It shall be completed without modifying/adding headings or logo, format or font.



QA/QC procedures (to be) applied	According to national standards.
Any comment	If the data on the average ash content of sorted fraction and average water content of sorted fraction extracted from the heap in the period y are not available to the developer, or are irregular with the high level of uncertainty, they are taken equal to the corresponding nationwide indicators (guide of quality indicators, amount of coal production and release of enrichment products, Ministry of Coal Industry of Ukraine, State Committee of Ukraine).

Table 10 – Average water content of extracted from waste heap coal as a result of the project activity

Data/Parameter	P_{WHB}
Data unit	dimensionless unit
Description	Correction factor, determining the probability of spontaneous combustion of the waste heap
Time of <u>determination/monitoring</u>	Fixed ex-ante
Source of data (to be) used	Report on the fire risk of Lugansk Region's waste heaps, Scientific Research Institute "Respirator", Donetsk, 2012
Value of data applied (for ex ante calculations/determinations)	0.78
Justification of the choice of data or description of measurement methods and procedures (to be) applied	Last updated specific data available at the time of determination, verification
QA/QC procedures (to be) applied	According to national standards.
Any comment	No

Table 11 – Correction factor, determining the probability of spontaneous combustion of the waste heap

Data/Parameter	$NCV_{Coal,y}$
Data unit	TJ/kt
Description	Net calorific value of coal
Time of <u>determination/monitoring</u>	Fixed ex-ante
Source of data (to be) used	National Inventory Report of Ukraine 1990-2010 p. 456, 462, 468 (1.A.1.a – Public Electricity and Heat Production)
Value of data applied (for ex ante calculations/determinations)	2008 – 21.5 2009 – 21.8 2010 – 21.6 2011 – 21.6 2012 – 21.6
Justification of the choice of data or description of measurement methods and procedures (to be) applied	Last updated specific data available at the time of determination, verification.
QA/QC procedures (to be) applied	According to national standards.

This template shall not be altered. It shall be completed without modifying/adding headings or logo, format or font.



applied	
Any comment	No

Table 12 – Net calorific value of coal

Data/Parameter	$k_{Coal,y}^C$
Data unit	t C/TJ
Description	Carbon content of coal
Time of determination/monitoring	Fixed ex-ante
Source of data (to be) used	National Inventory Report of Ukraine 1990-2010, p.458, 464, 470 (1.A.1.a – Public Electricity and Heat Production)
Value of data applied (for ex ante calculations/determinations)	2008 – 25.95 2009 – 25.97 2010 – 25.99 2011 – 25.99 2012 – 25.99
Justification of the choice of data or description of measurement methods and procedures (to be) applied	Last updated specific data available at the time of determination, verification.
QA/QC procedures (to be) applied	According to national standards.
Any comment	No

Table 13 – Carbon content of coal

Data/Parameter	$OXID_{Coal,y}$
Data unit	dimensionless unit
Description	Carbon oxidation factor of coal
Time of determination/monitoring	Fixed ex-ante
Source of data (to be) used	National Inventory Report of Ukraine 1990-2010 p. 459, 465, 471 (1.A.1.a – Public Electricity and Heat Production)
Value of data applied (for ex ante calculations/determinations)	2008 – 0.963 2009 – 0.963 2010 – 0.962 2011 – 0.962 2012 – 0.962
Justification of the choice of data or description of measurement methods and procedures (to be) applied	Last updated specific data available at the time of determination, verification.
QA/QC procedures (to be) applied	According to national standards.
Any comment	No

Table 14 – Carbon oxidation factor of coal

This template shall not be altered. It shall be completed without modifying/adding headings or logo, format or font.



Data/Parameter	$A_{coal,y}$
Data unit	%
Description	Average ash content of thermal coal extracted in Lugansk region of Ukraine
Time of <u>determination/monitoring</u>	Fixed ex-ante
Source of data (to be) used	Guide of quality, volume of coal production and enrichment products in 2008-2010, Ministry of Coal Industry of Ukraine, State Committee of Ukraine, and Lugansk 2010 (see Annex 4). Values for thermal coal
Value of data applied (for ex ante calculations/determinations)	2008 – 37.20 2009 – 38.40 2010 – 38.10 2011 – 38.10 2012 – 38.10
Justification of the choice of data or description of measurement methods and procedures (to be) applied	Statistical data At the time of determination, verification data are available
QA/QC procedures (to be) applied	According to national standards.
Any comment	No

Table 15 – Average ash content of thermal coal extracted in Lugansk region of Ukraine

Data/Parameter	$W_{coal,y}$
Data unit	%
Description	Average water content of thermal coal extracted in Lugansk region of Ukraine
Time of <u>determination/monitoring</u>	Fixed ex-ante
Source of data (to be) used	Guide of quality, volume of coal production and enrichment products in 2008-2010, Ministry of Coal Industry of Ukraine, State Committee of Ukraine, and Lugansk 2010 (see Annex 4). Values for thermal coal
Value of data applied (for ex ante calculations/determinations)	2008 – 7.2 2009 – 7.4 2010 – 7.4 2011 – 7.4 2012 – 7.4
Justification of the choice of data or description of measurement methods and procedures (to be) applied	Statistical data At the time of determination, verification data are available
QA/QC procedures (to be) applied	According to national standards.
Any comment	No

Table 16 – Average water content of thermal coal extracted in Lugansk region of Ukraine

This template shall not be altered. It shall be completed without modifying/adding headings or logo, format or font.

**B.2. Description of how the anthropogenic emissions of greenhouse gases by sources are reduced below those that would have occurred in the absence of the JI project:**

The following step-wise approach is used to demonstrate that reduction of anthropogenic emissions from sources that is provided by the project activity is additional to any other emission reductions:

Step 1. Indication and description of the approach applied

According to Paragraph 44 (b) of the Annex 1 of the Guidance “Guidance on Criteria for Baseline Setting and Monitoring” version 03, additionality can be demonstrated by provision of traceable and transparent information showing that the same approach for additionality demonstration has already been taken in cases for which determination is deemed final and which can be regarded as comparable, using the criteria outlined for baseline determination in paragraph 12 of the Guidance. It was decided to refer to the positively determined project “Processing of Waste Heaps at “Monolith-Ukraine”²¹ (ITL Projects ID: UA1000034). This, project already implemented or the one that will be implemented with comparable conditions (the same measures to reduce the negative impact of GHG, the same country, similar technology, similar scale), will have as a result reduction of anthropogenic emissions by sources or enhancement of net removals by sinks that are additional to any that would have been in the absence of the project, and also relevant to this project.

Step 2. Application of the approach chosen

The following steps are performed to demonstrate additionality of this project:

Sub step 2a: Identify comparable project where an accredited independent entity has already positively determined that it would result in a reduction of anthropogenic emissions by sources or an enhancement of net anthropogenic removals by sinks that is additional in the absence the project.

The project “Processing of Waste Heaps at “Monolith-Ukraine” was selected as the comparable JI project. Accredited independent entity has already positively determined that it would result in a reduction of anthropogenic emissions by sources or an enhancement of net anthropogenic removals by sinks that is additional to any that would otherwise occur. This determination has already been deemed final by the JISC.

Sub step 2b: Demonstrate that the identified project is a comparable project (to be) implemented under comparable circumstances:

In accordance with paragraphs 44 and 12 of Guidelines on criteria for baseline setting and monitoring version 03 we will demonstrate that projects are implemented under comparable circumstances:

1. Both projects propose **the same measures on GHG emissions reduction into the atmosphere:** complex of measures on thermal coal extraction from the waste heaps is implemented, which were formed as a result of the coal mines activity. The result of processing rock mass of the waste heaps is the reduction of GHG emissions level that would have occurred due to their spontaneous combustion and subsequent burning. Besides additional amount of thermal coal is received, which will replace coal from mine and partly meet the needs in energy production. Same sources of GHG emissions are included in the boundaries of both projects – project equipment and waste heaps.
2. **Projects are implemented in the same geographical area.**
Both projects are implemented in Lugansk region, Ukraine.
3. **Both projects have a similar scale:**
Projects are Joint Implementation large-scale projects. Large amount of enrichment and auxiliary equipment is used for processing rock mass of the waste heaps. Both projects process a large amount of rock mass and recultivate wastes of the coal industry.

²¹ <http://ji.unfccc.int/UserManagement/FileStorage/P21NS8K075WULAO9GHFER3TI6M4YBD>



4. **Both projects are implemented under identical conditions of legislation:**

During the time interval between the dates of implementation of two JI projects regulatory and legal frameworks bases have not undergone significant changes. The situation around the coal industry remained stable.

5. **Both projects introduce similar technology:**

Technology, which is implemented in the proposed and comparable projects, is similar. In both projects, waste heaps are dismantled using standard excavators and bulldozers. Material from heaps is transported to installation for rock mass beneficiation using trucks. In both projects, wet method of rock beneficiation is used. In both projects the nominal power plants is approximately 100,000 tons of rock mass tonnes per month. In both projects difficult environmental hydro cyclones are used that separate coal fraction from barren rock. Both technologies use closed system of water use, preventing additional impact on the environment. Both technologies are modern and efficient, aimed at enriching rock mass of the waste heaps.

Thus the criteria identified by the Guidance are satisfied and the identified project is indeed a comparable projects implemented under comparable circumstances.

Step 3: Justification why determination of the comparable project refers to this project

The project “Processing of Waste Heaps at “Monolith-Ukraine” and the proposed project are implemented within the same geographic region of Ukraine – the Donbas coal mining region. The implementation timeline is quite similar. Projects will share the same investment profile and market environment. These projects are implemented by private companies with no utilization of public funds. The investment climate will be comparable in both cases with the coal sector being an almost non-profitable sector in Ukraine²² burdened by many problems. The market for the extracted coal will also be similar for projects as these are small private companies that will not be able to sell coal in big quantities under long-term contracts. Ukrainian coal sector is largely state-controlled. Energy and Coal Ministry of Ukraine decides production level of state mines, based on their performance. After this, state controlled mines sell their coal to the state Trading Company “Coal of Ukraine”. This company also buys coal from private mines and arranges supply of coal to thermal electricity companies. Prices for coal mines differ significantly for public and private mines²³.

Both projects also share the investment climate of Ukraine which is far from being favourable. Ukraine is considered to be a high risk country for doing business and investing in. Almost no private capital is available from domestic or international capital markets for mid to long term investments, and any capital that is available has high cost. The table below represents risks of doing business in Ukraine according to various international indexes and studies.

Indicators	2009	Note
Corruption index of Transparency International ²⁴	152 position from 183	Index of corruption
Rating of business practices of The World Bank (The Doing Business) ²⁵	149 position from 178	Rating of conduct of business (ease of company opening, licensing, staff employment, registration of ownership, receipt of credit, defence of interests of investors)
The IMD World Competitiveness Yearbook ²⁶	48 position from 55	Research of competitiveness (state of economy, efficiency of government, business efficiency and state

²² http://www.necu.org.ua/wp-content/plugins/wp-download_monitor/download.php?id=126

²³ http://www.ier.com.ua/files/publications/Policy_papers/German_advisory_group/2009/PP_09_2009_ukr.pdf

²⁴ http://cpi.transparency.org/cpi2011/in_detail/

²⁵ <http://www.doingbusiness.org/rankings>



		of infrastructure)
Index of Economic Freedom of Heritage Foundation ²⁷	164 position from 180	Determination of degrees of freedom of economy (business, auction, financial, monetary, investment, financial, labour freedom, freedom from Government, from a corruption, protection of ownership rights)
Global Competitiveness Index of World Economic Forum ²⁸	77 position from 134	Competitiveness (quality of institutes, infrastructure, macroeconomic stability, education, development of financial market, technological level, innovative potential)

Table 17 – International ratings of Ukraine

The data above shows that both real and perceived risks of investing in Ukraine are in place and influence the availability of capital in Ukraine both in terms of size of the investments and in terms of capital costs. Comparison of commercial lending rates in Ukraine and in the euro zone for loans for 4 years in Euros is presented in the figure below:

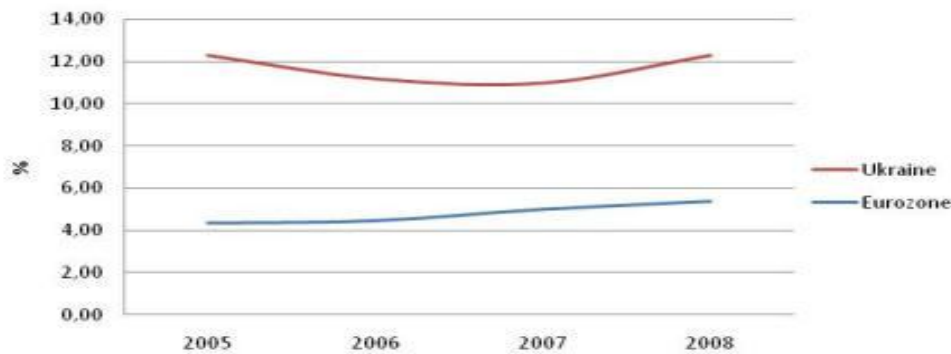

Figure 8 – Commercial lending rates, Euros, for four years

As stated at the Organization for Economic Co-operation and Development Roundtable on Enterprise Development and Investment Climate in Ukraine, the current legal basis is not only inadequate, but to a large extent it sabotages the development of market economy in Ukraine. Voices in the western press can basically be summarized as follows: The reforms in the tax and legal systems have improved considerably with the adoption of the commercial Code, Civil Code and Customs Code on 1 January 2004 and new Tax Code on 1 January 2011 but still contain unsatisfactory elements and pose a risk for foreign investors²⁹. Ukraine is considered to be heading in the right direction with significant reforms having been put into action but still has a long way to go to realize its full potential. Frequent and unpredictable changes in the legal system along with conflicting and inconsistent Civil and Commercial Codes do not allow for a transparent and stable enforced legal business environment. This is perceived as a great source of uncertainty by international companies, which make future predictions of business goals and strategy risky.

The conclusion from the abovementioned is as follows: the investment climate of Ukraine is risky and unwelcoming, private capital is not available from domestic or international sources or available at

²⁶ <http://www.imd.org/research/publications/wcy/upload/scoreboard.pdf>

²⁷ <http://www.heritage.org/index/country/ukraine>

²⁸ <http://reports.weforum.org/global-competitiveness-2011-2012/>

²⁹ Foreign Direct Investment in Ukraine – Donbas, Philip Burris, Problems of foreign economic relations development and attraction of foreign investments: regional aspect. ISSN 1991-3524, Donetsk, 2007. p. 507-510



prohibitively high cost due to real and perceived risks of doing business in Ukraine as shown by various sources. Alternatives markets, such as Russia, offer similar profile of investment opportunities with lower risk and better business environment.

Subject to the above information, we can conclude that determination of the project “Processing of Waste Heaps at “Monolith-Ukraine” is relevant for this project.

Outcome of the analysis: According to Paragraph 44 (b) of Appendix 1 of “Guidance on criteria for baseline setting and monitoring”, Version 03, additionality was demonstrated by providing traceable and transparent information that similar approach to demonstrating additionality has already been applied in those cases, where determination is considered final and can be taken as comparable one using criteria for determining the baseline in Paragraph 12 of Guidance, as well as traceable and transparent information that has received positive determination by accredited independent entity that comparative project “Processing of Waste Heaps at “Monolith-Ukraine” (ITL Projects ID: UA1000034) is implemented under comparable circumstances (similar technologies, similar technology, similar implementation time, similar project scale), would result in a reduction of anthropogenic emissions sources or an enhancement of net anthropogenic removals by sinks that is additional to any that would otherwise occur and have provided justification on why this determination is relevant for the project at hand. Overall, this project is additional.

B.3. Description of how the definition of the project boundary is applied to the project:

Decision on implementation of this project was taken on March 10, 2008. “AGS-2008” LLC, basing on the concluded with the customer contract No.118/04-2009 dated 18/04/2009 commits itself to perform works on technical mining recultivation of the waste heaps #1,2,3, located on the territory of settlement Verhnyoherasymivka, Krasnodonskiy District, Lugansk region, Ukraine. “AGS-2008-2008” LLC rents enrichment complex that belongs to “ENERGOCEMENT”, basing on the concluded with the customer contract №115/05-2009 dated 15/05/2009. For performing works on dismantling the waste heap and transportation of rock mass to enrichment complex JI project owner entered into agreement with the company-contractor of “SMU” LLC №119/05-2009 dated 19/05/2009, which will implement these works. “AGS-2008-2008” LLC is the JI project owner and developer of the project design documentation simultaneously.

Thermal coal extracted from the waste heap will be supplied to the thermal coal market partially replacing coal that would be mined in the baseline scenario in the coal mines. In turn, the project scenario provides project GHG emissions in the atmosphere related to diesel burning by trucks and indirect carbon dioxide emissions during electricity consumption by technological equipment.

According to the baseline, all amount of coal is extracted in coal mines, and delivered to in the energy industry sector for energy generation. Source of emissions from combustion of this coal at TPPs is equivalent to the source, present in the project scenario, so source of GHG emissions from the burning of this coal at TPP excluded from consideration. In addition, coal extraction by mining method leads to fugitive CMM emissions, warming potential of which is in 21 times higher than CO₂. Coal mine utilizes different types of energy, but electricity consumption takes the bulk of the energy balance of coal enterprises, about³⁰ 90%. The remaining 10% of the balance of energy consumption is not considered in order to provide conservativeness. Emission sources in this PDD are presented in accordance with the provisions of Articles 13 and 14 of the JISC Guidance.

Leakage:

³⁰ *THE EFFECTIVE METHOD OF ELECTRICITY CONSUMPTION CONTROL AT COAL MINES Gryaduschy B.A., Doctor of Technical Sciences, DonUGI, Lisovoy G.N., Myalkovsky V.I., ChehlatyN.A., Candidates scientific degree of Technical science, NIIGM named after Fedorov M. M., Donetsk, Ukraine*

This template shall not be altered. It shall be completed without modifying/adding headings or logo, format or font.



Leakage is the net change of anthropogenic emissions by sources and/or removals by sinks of GHGs which is done outside the project boundary, and that can be measured and is directly attributable to the JI project.

This project will result in a net change in of anthropogenic emissions by sources and/or removals by sinks of GHGs come from two sources:

- Leakages caused by fugitive methane emissions during coal production in coal mines;
- Leakages related to electricity consumption from the grid of Ukraine during coal production in the mine.

In the baseline scenario coal production by mining method is implemented (underground coal mines), while *fugitive emissions of coal mine methane* appear. In the project scenario, additional amount of thermal coal is extracted, using wet method of rock mass beneficiation of the waste heap, which otherwise would be burned. Therefore, coal produced by the project activity substitutes the coal would have been otherwise mined in the baseline scenario that would cause fugitive methane emissions. Thus, coal extraction from the waste heap will cause methane emissions.

As reliable and accurate national data on fugitive methane emissions associated with the production of coal are available, project participants used this data to calculate the amount of fugitive CH₄.

This leakage is measurable: through the same procedure as used in 2006 IPCC Guidelines³¹ (See Volume 2, Chapter 4, p. 4-11) and also used in CDM approved methodology ACM009³² Version 03.2 (p. 8). Activity data (in our case amount of coal extracted from the waste heap which is monitored directly) is multiplied by the multi-project carbon emission factor for fugitive methane emissions from coal mining (which is sourced from the relevant national study – National Inventory Report³³ of Ukraine under the Kyoto Protocol) and conversion coefficients. It is important to mention that IPCC and relevant National Inventories take into account raw amount of coal that is being mined in these calculations whereas in the PDD coal extracted from the waste heaps is high quality coal concentrate. Therefore, approach taken in the PDD is conservative as in coal mining more ROW coal should be mined causing more fugitive methane emissions to produce equivalent amount of high quality coal concentrate.

Electricity consumption and related with this greenhouse gas emissions during waste heap dismantling will be included in the calculation of the project emissions. *Carbon dioxide emissions as a result of electricity consumption*, during coal mining in the amount that equals to the project amount of coal, is leakage that can be taken into account on the basis of State Statistics Committee³⁴ about the specific electricity consumption during coal production in the mines of Ukraine in the relevant year. Data in this link indicates that the specific level of electricity consumption during coal mining is higher than the specific electricity consumption from grid in the project scenario.

Leakages as a result of consumption of other types of energy carriers during coal production in the mines are insignificant in comparison to the leakages as a result of electricity consumption³⁵, so in this respect, and for reasons of conservatism, we will take them equal to zero.

³¹ http://www.ipcc-nggip.iges.or.jp/public/2006gl/pdf/2_Volume2/V2_4_Ch4_Fugitive_Emissions.pdf

³² <http://cdm.unfccc.int/UserManagement/FileStorage/K4P3YG4TNQ5ECFNA8MBK2QSMR6HTEM>

³³ http://unfccc.int/files/national_reports/annex_i_ghg_inventories/national_inventories_submissions/application/zip/ukr-2012-nir-13apr.zip

³⁴ <http://www.ukrstat.gov.ua/>

³⁵ *THE EFFECTIVE METHOD OF ELECTRICITY CONSUMPTION CONTROL AT COAL MINES* Gryaduschy B.A., Doctor of Technical Sciences, DonUGI, Lisovoy G.N., Myalkovsky V.I., Chehlaty N.A., Candidates scientific degree of Technical science, NIIGM named after Fedorov M. M., Donetsk, Ukraine www.mishor.esco.co.ua/2005/Thesis/10.doc

This template shall not be altered. It shall be completed without modifying/adding headings or logo, format or font.



This leakage is directly attributable to the JI project activity according to the following assumption: the coal produced by the project activity from the waste heap will substitute the coal produced by underground mines of the region in the baseline scenario. This assumption is explained by the fact that commercial output (coal), connected with fewer GHG emissions during production, will come on steam coal market and will substitute commercial output in the baseline scenario that is characterized by higher GHG emissions during its production. The project activity cannot influence general demand at steam market. In the baseline scenario demand for coal will stay the same and will be met by the traditional source – underground mines of the region. This methodological approach is very common and is applied in all renewable energy projects (substitution of grid electricity with renewable-source electricity, for example, project UA1000256 Construction of Wind Park Novoazovskiy), projects in cement sector (e.g. JI0144, on slag usage and switch from wet to semi-dry process at “Volyn-Cement” OJSC³⁶), projects in metallurgy sector (e.g. UA1000181 on construction of arc furnace steelmaking plant “Electrostal” at Kurakhovo, Donetsk Region³⁷) and others.

These leakages are significant and will be included in the calculation of the project emission reductions under the project. Procedure for ex ante estimate and quantification of this source of leakage is provided below:

<i>Data / Parameter</i>	<i>Data unit</i>	<i>Description</i>	<i>Data Source</i>	<i>Value</i>
GWP_{CH_4}	tCO ₂ e/ t CH ₄	Global warming potential of methane	IPCC Second Assessment Report ³⁸	21
ρ_{CH_4}	t/m ³	Methane density	2006 IPCC Guidelines for National Greenhouse Gas Inventories, Volume 2: Energy, Chapter 4: Fugitive Emissions, Page 4.12 ³⁹ . Value was converted from converted Gg·m ⁻³ to t/m ³ . IPCC default value under standard physical conditions (t=293,15 K; p=101,2325 kPa)	0.00067
$EF_{CH_4,CM}$	m ³ /t	Fugitive methane emissions factor during coal mines operation	National Inventory Report of Ukraine 1990-2010, p. 90	25.67
$N^e_{coal,y}$	MWh/t	Average consumption of electricity per tonne of extracted coal in Ukraine in year y	State Statistics Service of Ukraine. Fuel and energy resources of Ukraine, Statistical Yearbook ^{40, 41, 42} p. 300, Kyiv 2009 (See Annex 5)	2009 – 0.0905 2010 – 0.0926 2011 – 0.0842 2012 – 0.0842
$EF_{grid,y}$	tCO ₂ /MWh	Specific indirect carbon	National Environmental	2009 – 1.237

³⁶ http://ji.unfccc.int/JI_Projects/DB/PIQYRYMBQCEQOT0HOQM60MBQ0HXNYU/Determination/Bureau%20Veritas%20Certification1266348915.6/viewDeterminationReport.html

³⁷ <http://ji.unfccc.int/JIITLProject/DB/4THB9WT0PK6F721UQA5H6PTHZEXT4C/details>

³⁸ http://www.ipcc.ch/ipccreports/sar/wg_I/ipcc_sar_wg_I_full_report.pdf Page 22.

³⁹ http://www.ipcc-nggip.iges.or.jp/public/2006gl/pdf/2_Volume2/V2_4_Ch4_Fugitive_Emissions.pdf

⁴⁰ http://www.ukrstat.gov.ua/druk/katalog/m-e_res/Pal_en_res.zip

⁴¹ http://www.ukrstat.gov.ua/druk/katalog/kat_u/2012/sz_per_2010.zip

⁴² http://www.ukrstat.gov.ua/druk/katalog/kat_u/2012/sz_per_2010.zip



		dioxide emissions from electricity consumption by 2 nd class electricity consumers in accordance with Procedure for determining the class of consumers.	Investment Agency Orders: No.63 dated 15/04/2011 ⁴³ No.43 dated 28/03/2011 ⁴⁴ No.75 dated 12/05/2011 ⁴⁵	2010 – 1.225 2011 – 1.227 2012 – 1.227
--	--	--------------------------------------------------------------------------------------------------------------------------------------------------------------------	---------------------------------------------------------------------------------------------------------------------------------------------------	----------------------------------------------

Table 18 – List of constants used in the calculations of leakage

Leakages in period y are calculated as follows:

$$LE_y = LE_{CH_4,y} + LE_{EL,y} \quad (\text{Equation 4}),$$

where:

LE_y - Leakages as a result from the project implementation in period y , tCO₂e;

$LE_{CH_4,y}$ - Leakages related to the fugitive methane emissions during the operation of mines in period y , tCO₂e;

$LE_{EL,y}$ - Leakages as a result of electricity consumption from energy grid during coal mining in period y , tCO₂e.

Leakages related to the fugitive methane emissions during the operation of mines in period y are calculated as follows:

$$LE_{CH_4,y} = -FC_{BE,Coal,y} \cdot EF_{CH_4,CM} \cdot \rho_{CH_4} \cdot GWP_{CH_4} \quad (\text{Equation 5}),$$

where:

$FC_{BE,Coal,y}$ - Amount of coal that would be mined in the baseline scenario and consumed in the energy sector for energy production in period y , t;

$EF_{CH_4,CM}$ - Fugitive methane emissions factor during coal mining, m³/t;

ρ_{CH_4} - Methane density, t/m³;

GWP_{CH_4} - Global warming potential of methane, tCO₂e/tCH₄.

Amount of coal that would be mined in the baseline scenario and combusted for energy production is calculated according to equation (3) of this PDD.

Leakages related to electricity consumption from energy grid during coal mining in period y are calculated as follows:

$$LE_{EL,y} = -(FC_{BE,Coal,y} \cdot N^{e_{coal,y}} \cdot EF_{grid,y}) \quad (\text{Equation 6}),$$

where:

$FC_{BE,coal,y}$ - Amount of coal that would be mined in the baseline scenario and consumed in the energy sector for energy production in period y , t;

⁴³ <http://www.neia.gov.ua/nature/doccatalog/document?id=127172>

⁴⁴ <http://www.neia.gov.ua/nature/doccatalog/document?id=126006>

⁴⁵ <http://www.neia.gov.ua/nature/doccatalog/document?id=127498>



- $N_{coal,y}^E$ - Average consumption of electricity per tonne of extracted coal in Ukraine in period y , MWh/t;
- $EF_{grid,y}$ - Specific indirect carbon dioxide emissions from electricity consumption by 2nd class electricity consumers in accordance with Procedure for determining the class of consumers, tCO₂/MWh.

The table below demonstrates all sources of GHG emissions under the project:

	Source	Gas	Included/Excluded	Justification/Explanation
Baseline scenario	Waste heap burning	CO ₂	Included	Main emission source
	Coal combustion	CO ₂	Excluded	This coal is extracted from the waste heaps. This emission source is equal to the one present in the baseline scenario and, therefore is excluded from consideration.
Project scenario	Coal combustion	CO ₂	Excluded	This coal is extracted from the waste heaps. This emission source is equal to the one present in the baseline scenario and, therefore is excluded from consideration.
	Electricity consumption from the grid as a result of project activity	CO ₂	Included	Main emission source
	Burning diesel fuel by trucks as a result of project activity	CO ₂	Included	Main emission source
Leakage	Leakages related to the fugitive methane emissions during the operation of mines	CH ₄	Included	These emissions are attributable to baseline scenario, which provides fugitive methane emissions as a result of coal production by coal mining
	Leakages as a result of electricity consumption from the grid at coal production in mines	CO ₂	Included	These emissions are attributable to baseline scenario, which provides coal production in coal mines
	Consumption of other types of energy carriers during mine operating	CO ₂	Excluded	These leakages are not significant, but also for reasons of conservatism, they are excluded from consideration.

Table 19 – Demonstration of emission sources

Baseline scenario:

The baseline scenario is the continuation of the existing situation. Coal is produced by the underground mines and is used for energy generation. Waste heaps are often self-heating and burning that causes CO₂ emissions into the atmosphere. Emission sources in the baseline that are included into the project boundary are:

- CO₂ emissions related to waste heap combustion.

Project scenario:

Project scenario provides GHG emissions from combustion of diesel fuel by transport operating in the project activity and from electricity consumption by technological equipment.

Emission sources in the project scenario are:

- Project emissions as a result of consumption of diesel fuel by project activity in period *y*;
- Project emissions as a result of electricity consumption from the grid by project activity in period *y*.

Leakage:

The proposed project provides availability of leakages, related to the operation of coal mines.

Emission sources are:

- Fugitive CMM emissions during operation of coal mines;
- Indirect CO₂ emissions related to electricity consumption during the operation of coal mines.

For demonstration of the boundaries of the project and emission sources in the baseline and project scenarios there are following figures:

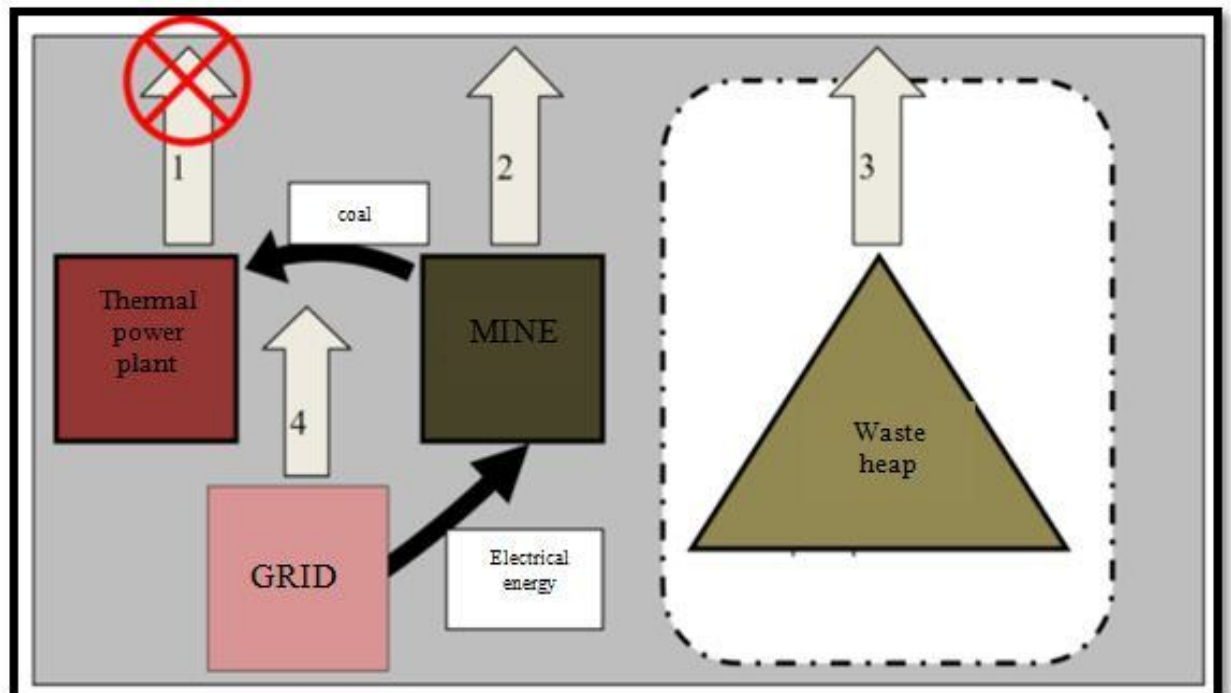

Figure 9 – Baseline boundaries of the project

This template shall not be altered. It shall be completed without modifying/adding headings or logo, format or font.

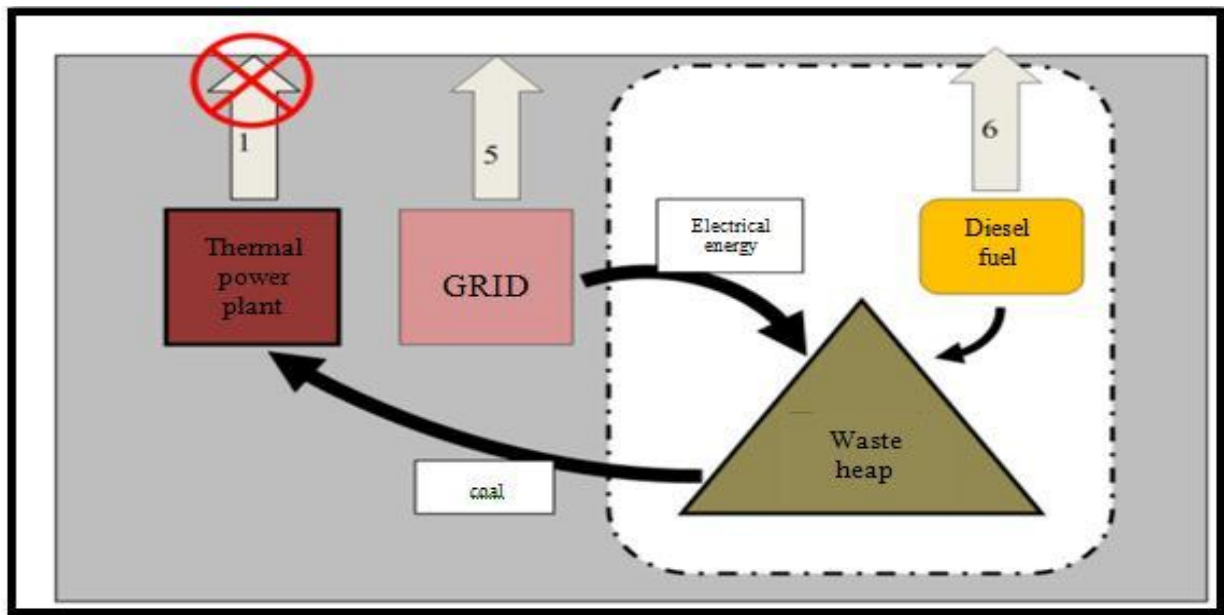

Figure 10 – Project boundaries of the project

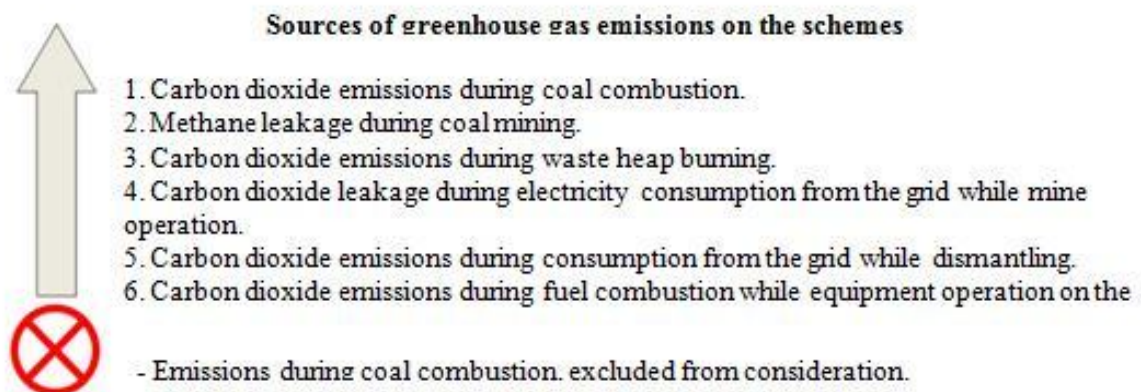

Figure 11 – Symbols in schematic diagram of the project boundaries

B.4. Further baseline information, including the date of baseline setting and the names of the persons/entities setting the baseline:

Date of baseline setting: 09/11/2012

Name of person/entity setting the baseline:

“AGS-2008” LLC is initiator of this project and developer of the project design documentation simultaneously. This company accompanies processes of receiving letter of support from SEIA, determination, receiving letter of approval from SEIA, registration, and verification of emission reductions achieved by the project “Carbonaceous rock processing and concentrating with the aim of reducing greenhouse gas emissions into the atmosphere”.

Contact details:

This template shall not be altered. It shall be completed without modifying/adding headings or logo, format or font.



Company name:	“AGS-2008” LLC
Company address:	83013, Donetsk, Stepna Street, b. 151-A
<i>Contact person:</i>	
Name:	Zagorskiy Sergiy Igorovych
Title:	Director
Phone:	+38 (063) 397 11 02
Fax:	
E-mail:	AGS-20082008.don@gmail.com

**SECTION C. Duration of the project/crediting period****C.1. Starting date of the project:**

Starting date of the project is March 10, 2008 – order No. 65 dated 10/03/2008 on the decision making to implement JI project under the Kyoto Protocol.

C.2. Expected operational lifetime of the project:

Expected operational lifetime of the project is estimated to last until 31/12/2013. Thus expected operational lifetime of the project will be 4 years and 7 months or 55 months. Length of the project lifecycle depends on the volumes of waste heaps, which are dismantled under the project. It is assumed that they will be dismantled by the end of 2013. Operating life of concentrating equipment without major overhauls ends in 2015.

C.3. Length of the crediting period:

Starting date of the crediting period: 01/06/2009.

End of the crediting period: 31/12/012

Duration of the crediting period: 3 years and 7 months or 43 months.

Starting date of generating emission reductions: 01/06/2009 – beginning of waste heaps dismantling and processing carbonaceous rock (this date is in acceptance certificate of concentrating complex).

Emission reductions generated after the crediting period may be used in accordance with an appropriate mechanism under the UNFCCC. The crediting period can extend subject to the approval by the Host Party.

**SECTION D. Monitoring plan****D.1. Description of monitoring plan chosen:**

Description and explanation of the monitoring plan chosen a step-wise approach is used:

Step 1. Indication and description of the approach chosen regarding monitoring

Option (a) provided by the document “Guidelines for users of the Joint Implementation project design document form” Version ⁴⁶ 04: JI specific approach is used for this project and therefore will be used for establishment of a monitoring plan.

Among other, monitoring plan includes the following:

- *Collecting and archiving all relevant data necessary for estimating or measuring anthropogenic emissions by sources of GHGs occurring within the project boundary during the crediting period;*
- *Collecting and archiving all relevant data necessary for determining the baseline of anthropogenic emissions by sources of GHGs within the project boundaries during the crediting period;*
- *Identification of all potential sources of, and the collection and archiving of data on increased anthropogenic emissions by sources of GHGs outside the project boundaries which are significant and reasonably attributable to the project during the crediting period;*
- *Quality assurance and control procedures for the monitoring process;*
- *Procedures for the periodic calculation of the reductions of anthropogenic emissions by sources by the proposed JI project, and for leakage effects, if any.*

Step 2. Application of the approach chosen

Key factors that affect emissions level under the project and under the baseline scenario were taken into account and described in detail in section B.1. The project activity will include monitoring of greenhouse gas emissions in the project and baseline scenarios. Detailed information on emission sources of the project and baseline is presented hereunder. The data relating to the monitoring of GHG emission reductions will be archived and kept at least 2 years after last transfer of ERUs to the buyer.

⁴⁶ <http://ji.unfccc.int/Ref/Documents/Guidelines.pdf>

***Baseline scenario:***

The basic scenario is the continuation of the existing situation. Coal is extracted in coal mines and used for energy production. Waste heaps are often prone to burning and self-heating, which results in CO₂ emissions into the atmosphere. The sources of emissions in the baseline scenario that are included in the project boundaries are:

- Carbon dioxide emissions related to waste heap burning.

Project scenario:

Project scenario provides GHG emissions from diesel fuel combustion by transport operating in the project activity and from electricity consumption by technological equipment.

Emission sources in the project scenario are:

- Project emissions because of diesel fuel consumption by project activity in period *y*;
- Project emissions due to electricity consumption from the grid by project activity in period *y*.

Leakage:

The proposed project provides availability of leakages related to the operation of coal mines.

Sources of leakages are:

- Fugitive CMM emissions during the operation of coal mines;
- Indirect CO₂ emissions related to electricity consumption during the operation of coal mines.

Carbon dioxide emissions as a result of combustion of thermal coal are calculated as emissions from stationary burnt coal in the amount equivalent to amount of coal extracted from heaps in the project scenario. This emission source can also be found in the project scenario and it is assumed that emissions are equivalent in the project and in the baseline scenarios. Therefore, this emission source is not considered in both cases.

Emission reduction as a result of the project implementation will be ensured by three main sources:

- Liquidation sources of carbon dioxide emissions as a result of burning of waste heaps by extracting thermal coal from it;
- Reducing the amount of fugitive methane emissions related to mine production by replacing the amount of such coal to the coal that is produced from the waste heaps as a result of the project activity;
- Reduction of electricity consumption from the grid during recultivation of the waste heaps in comparison with energy consumption during coal extraction in the mine.



During any period of monitoring data on the following parameters should be collected and registered:

1. Amount of electricity, consumed as a result of the project activity in the relevant period *y*.

For measurement of this parameter data of the company commercial is used. To confirm this parameter are used monthly acceptance certificates from the company-supplier of electricity. This parameter is recorded by the help of special energy meter. Meters are located directly behind the current transformers at the industrial site of concentrating mill. These meters record all electricity consumed within the project boundaries, as the access to the power grid is implemented through it only. Indications are used for commercial calculations with the company-supplier of electricity. Regular cross-checks with the company-supplier of electricity are carried out. The monthly and annual reports are based on these data.

2. Amount of diesel fuel, consumed by transport as a result of the project activity in the relevant period *y*.

For the metering of this parameter the commercial data of the company is used. Completion certificate from the company-contractor are used in order to confirm the amount of fuel consumed. Company-contractor performs works on the waste heap dismantling, transporting rock mass to the concentrating mill and other transportation services required by the project activity. Consumption of diesel fuel occurs only by trucks, excavators and bulldozers under the project, but if they will use additional types of transport that consume diesel fuel this consumption will also be taken into account. Amount of diesel fuel consumed in the accounting records is given in litres, so conversion of measuring unit for the amount of this fuel is implemented for monitoring purposes into tonnes using the density of 0.85 kg/l⁴⁷. Regular cross-checks between the project owner and the company-supplier are carried out. The monthly and annual reports are based on these data.

3. Amount of coal product, received by enrichment of carbonaceous rock as a result of project activity in the relevant period *y*.

This parameter is tracked basing on internal company documents. Monitoring of the amount of enriched coal is implemented according to acceptance certificates of shipped coal products to the buyer. For calculating GHG emission reductions only those products that are shipped to the buyer is taken into account and related to the project activity. Weighing is implemented at the industrial site of concentrating complex using special automobile scales. Motor transport of contracting company that provides transportation services brings up carbonaceous rock mass to the point of weighing – automobile scales. This parameter is not a monitoring one, but its fixing is for internal control of processed rock. In completion certificates from the contracting company, except fuel consumed, the amount of transported rock mass is indicated. After this weighing rock mass is transported to the reception point of concentrating complex, where using scraper conveyor raw material goes to the technological cycle. The final product of enrichment is coal concentrate is shipped to the warehouse of finished product. Using special equipment coal is loaded to the trucks which go to the weighting point. Cargo truck enters the platform of scales, and then the operator records the weight, writes data to the log and let the truck continue. The whole process of weighing takes about a minute. Regular cross-checks with buyers of coal products are performed to provide complete control under this

⁴⁷ DSTU 4840-2007 Diesel fuel. Specifications. Density is taken as highest, which is conservative. Values are converted from measurement units kg/m³ into kg/l.
This template shall not be altered. It shall be completed without modifying/adding headings or logo, format or font.



parameter. At the end of the month monthly technical report is prepared, annual reports based on these data are prepared. Information on the volumes of ROM coal production is stored in paper and electronic forms.

4. Ash and water content of coal products received by enrichment of carbonaceous rock as a result of project activity in the relevant period y.

Key indicators of the quality of coal products, obtained as a result of enriching rock mass of the waste heaps, are indicators of ash and moisture. The results of analyzes of Coal Chemistry Laboratory, which is the third independent party of the project, are used to confirm these parameters. Coal Chemistry Laboratory of “MCM “Bilorichenska” JSC provides certificates of quality for produced coal on a monthly basis. Coal Chemistry Laboratory of “MCM “Bilorichenska” JSC meets the criteria of certification and is certified for measurements conducting in the field of spreading state metrological control according to the certificates No.207 dated August 29, 2008 and No.285 dated September 23, 2011. Studies of samples of extracted coal may be performed at the request of the consumer on the contrary to the internal regulations. Results of laboratory studies are stored in paper and electronic forms. Quantitative indicators of coal ash and water content are determined in accordance with normative documents: ISO 4096-2002, GOST 27314-91, GOST11022-95 and others. If the data on the average ash content and average water content of enriched coal, extracted from the heap in period y, is not available for the developer, or is irregular with a high level of uncertainty, they are taken equal to the corresponding of nationwide parameters.

More detailed information on the parameters used in the baseline scenario presented in Annex 2 of this PDD.

Data and parameters that were not monitored during the whole crediting period, are determined only once (and remain constant during the whole crediting period) and are available at the stage of determination of the PDD, are listed in the table below:

<i>Data / Parameter</i>	<i>Data unit</i>	<i>Description</i>	<i>Data Source</i>	<i>Value</i>
GWP_{CH_4}	tCO ₂ e/ t CH ₄	Global warming potential of methane	IPCC Second Assessment Report ⁴⁸	21
ρ_{CH_4}	t/m ³	Methane density	2006 IPCC Guidelines for National Greenhouse Gas Inventories, Volume 2: Energy, Chapter 4: Fugitive Emissions, Page 4.12 ⁴⁹ . Value was converted from	0.00067

⁴⁸ http://www.ipcc.ch/ipccreports/sar/wg_I/ipcc_sar_wg_I_full_report.pdf Page 22.

⁴⁹ http://www.ipcc-nggip.iges.or.jp/public/2006gl/pdf/2_Volume2/V2_4_Ch4_Fugitive_Emissions.pdf



			converted $Gg \cdot m^{-3}$ to t/m^3 . IPCC default value under standard physical conditions ($t=293,15$ K; $p=101,2325$ kPa)	
P_{WHB}	dimensionless unit	Correction factor, determining the probability of spontaneous combustion of the waste heap	Report on the fire risk of Lugansk Region's waste heaps, Scientific Research Institute "Respirator", Donetsk, 2012	0.78
$EF_{CH_4,CM}$	m^3/t	Fugitive methane emissions factor during coal mines operation	National Inventory Report of Ukraine 1990-2009, p. 90	25.67
$NCV_{Coal,y}$	TJ/kt	Net calorific value of coal in year y	National Inventory Report of Ukraine ⁵⁰ 1990-2010 p. 462, 468 (1.A.1.a – Public Electricity and Heat Production)	2009 – 21.8 2010 – 21.6 2011 – 21.6 2012 – 21.6
$OXID_{Coal,y}$	dimensionless unit	Carbon oxidation factor of coal in year y	National Inventory Report of Ukraine 1990-2010 p. 465, 471 (1.A.1.a – Public Electricity and Heat Production)	2009 – 0.963 2010 – 0.962 2011 – 0.962 2012 – 0.962
$k_{Coal,y}^C$	t C/TJ	Carbon content of coal in year y	National Inventory Report of Ukraine 1990-2010 p. 464, 470 (1.A.1.a – Public Electricity and Heat Production)	2009 – 25.97 2010 – 25.99 2011 – 25.99 2012 – 25.99
$A_{coal,y}$	%	Average ash content of thermal coal extracted in Lugansk region, Ukraine	Guide of quality, volume of coal production and enrichment products in 2008-2010, Ministry of Coal Industry of Ukraine, State Committee of Ukraine, Lugansk 2010 (see Annex 4). Indicators for thermal coal.	2009 – 38.40 2010 – 38.10 2011 – 38.10 2012 – 38.10
$W_{coal,y}$	%	Average water content of thermal coal extracted in Lugansk region, Ukraine	Guide of quality, volume of coal production and enrichment products in 2008-2010, Ministry of Coal Industry of Ukraine, State Committee of Ukraine, Lugansk 2010 (see Annex 4). Indicators for thermal coal.	2009 – 7.4 2010 – 7.4 2011 – 7.4 2012 – 7.4

⁵⁰ http://unfccc.int/national_reports/annex_i_ghg_inventories/national_inventories_submissions/items/5888.php



$N^e_{coal,y}$	MWh/t	Average consumption of electricity per tonne of extracted coal in Ukraine in year y	State Statistics Service of Ukraine. Fuel and energy resources of Ukraine, Statistical digest ^{51, 52, 53} p.300, Kyiv 2009 (see Annex 5)	2008 – 0.0878 2009 – 0.0905 2010 – 0.0926 2011 – 0.0842 2012 – 0.0842
$NCV_{diesel,y}$	TJ/kt	Net calorific value of diesel fuel in year y	National Inventory Report of Ukraine 1990-2010 ⁵⁴ p.476, 479 (value for mobile combustion, off-road transportation)	2009 – 42.3 2010 – 42.5 2011 – 42.5 2012 – 42.5
$OXID_{diesel,y}$	ratio	Carbon oxidation factor of diesel fuel in period y	National Inventory Report of Ukraine 1990-2010 p. 478, 481 (value for mobile combustion, off-road transportation)	2009 – 0.99 2010 – 0.99 2011 – 0.99 2012 – 0.99
$k^C_{diesel,y}$	t C/TJ	Carbon content of diesel fuel in period y	National Inventory Report of Ukraine 1990-2010 p. 478, 481 (value for mobile combustion, off-road transportation)	2009 – 20.20 2010 – 20.20 2011 – 20.20 2012 – 20.20
$EF_{grid,y}$	tCO ₂ /MWh	Specific indirect carbon dioxide emissions from electricity consumption by 2 nd class electricity consumers in accordance with Procedure for determining the class of consumers.	National Environmental Investment Agency Orders: No. 63 dated 15.04.2011 for 2009 No. 43 dated 28.03.2011 for 2010 No. 75 dated 12.05.2011 for 2011 (2012)	2009 – 1.237 2010 – 1.225 2011 – 1.227 2012 – 1.227

Table 20 – List of constants used in calculations of emissions

The data and parameters that are not monitored throughout the crediting period but are determined only once (and thus remain fixed throughout the crediting period), and that are available already at the stage of determination.

⁵¹ http://www.ukrstat.gov.ua/druk/katalog/m-e_res/Pal_en_res.zip

⁵² http://www.ukrstat.gov.ua/druk/katalog/kat_u/2012/sz_per_2010.zip

⁵³ http://www.ukrstat.gov.ua/druk/katalog/kat_u/2012/sz_per_2010.zip

⁵⁴ http://unfccc.int/national_reports/annex_i_ghg_inventories/national_inventories_submissions/items/5888.php



All parameters taken for calculations of GHG emission reductions under the project, and sources of which are National Inventory Report of Ukraine 1990-2010, as well as data of State Statistics Service of Ukraine and DFP of Ukraine (SEIA), publications of the Intergovernmental Panel on Climate Change and publications of the Intergovernmental Panel on Climate Change and research on fire hazard of waste heaps, which are held by Scientific Research Institute “Respirator”, can be updated in case of publication of new relevant documents. If data for the current period are not available, the last available data are taken into calculation of GHG emission reductions.

The data and parameters that are monitored throughout the crediting period:

- $EC_{PJ,y}$ - Amount of electricity, consumed as a result of the project activity in the relevant period y ;
- $FC_{PJ,Diesel,y}$ - Amount of diesel fuel that was consumed by transport as a result of the project activity in the relevant period y ;
- $FR_{Coal,y}$ - Amount of coal products, which were received by enrichment of carbonaceous rock as a result of the project activity in the relevant period y ;
- $A_{enrich,y}$ - Average ash content of enriched coal extracted from the waste heaps in the relevant period y ;
- $W_{enrich,y}$ - Average water content of enriched coal extracted from the waste heaps in the relevant period in the relevant period y .

Setup of measurement installation

Measurement of certain parameters that are to be monitored in this project goes as follows:

1. Amount of electricity, consumed as a result of the project activity is measured using the special meter, which is multifunction device for measurement of electric energy. Electricity meter runs regular calibration in accordance with the internal regulations of the Host party. For the calibration of meter representatives of the State Metrology Service of Ukraine are involved.
2. Amount of coal products, which were received by enrichment of carbonaceous rock as a result of the project activity is measured by special automobile scales. All scales are under the control of the relevant persons who are responsible for their functional status. For the calibration of scales representatives of the State Metrology Service of Ukraine are involved. Any changes, substitution or verify the functionality of all scales are recorded in the technical passports of these devices.
3. Amount of diesel fuel, which was consumed by transport by the project activity, will be confirmed by completion certificates from company-contractor. This document provides information on the volumes of consumed diesel fuel, details of the parties and seals. Reliability and transparency of data is due to the fact that completion certificates are provided by the third disinterested party.



4. Indicators of ash and water content of enriched coal are determined by independent laboratory that analyzes samples of the extracted coal, and presents the results of the analysis in certificates of product quality. Buyer of coal products has free access to this information. Procedures for conducting studies meet the following regulations: ISO 4096-2002, GOST 27314-91, GOST11022-95 and others.

Measuring devices

All measuring devices operating within the project activity will undergo regular periodic calibration procedures according to the characteristics of their passport, and according to the technical rules of the Host Party. Appointed person will be responsible for controlling and serviceability of measuring devices (see Section D.3). Representatives of the State Metrology System of Ukraine will be involved for calibration of measuring devices.

For measuring electricity consumption different multifunctional electric energy meter is used. It takes into account all electricity consumed within the project activity. According to the passport data of electricity meter interval between calibration is 6 years. More detailed information on conducting calibration of meters will be given in the monitoring report. Measuring equipment used under the project is presented below:

1. Electricity meter “SL 7000 Smart”;
2. Automobile scales “BA-60CM”.

Scales for weighing coal products undergo regular calibration with periodicity of 1 year according to the internal regulations of the host Party and device specifications.

Archiving, data storage and record handling procedure

Documents and reports on the data that are monitored will be archived and stored by the project participants. The following documents will be stored: primary documents for the accounting of monitored parameters in paper form; intermediate reports, orders and other monitoring documents in paper and electronic form; documents on measurement devices in paper and electronic form. These documents and other data monitored and required for determination and verification, as well as any other data that are to be monitored and are necessary for verification must be kept for two years after the last transfer of ERUs to the buyer. If expected data for monitoring concerning the production of coal is not available (that is used for calculating baseline emissions and leakages), they will not be taken into account and emission reductions will not be included. If there are no data of parameters used to calculate project emissions: consumption of electricity or diesel fuel, average specific data on consumption for the previous periods will be used. This is a conservative.

Training of monitoring personnel



Training on safety issues is mandatory and must be provided to all personnel of the project as required by local regulations. Procedure for safety trainings includes the scope of the trainings, training intervals, forms of training, knowledge checks etc. The project host management will maintain records for such trainings and periodic knowledge check-ups.

Activities that are directly related to the monitoring do not require specific training other than provided by the professional education. Thus, personnel, responsible for monitoring, will receive training on monitoring procedures and requirements.

Procedures identified for corrective actions in order to provide for more accurate future monitoring and reporting

In cases if any errors, fraud, inconsistencies or situations when monitoring data are unavailable will be identified during the monitoring process special commission will appointed by project host management that will conduct a review of such case and issue an order that must also include provisions for necessary corrective actions to be implemented that will ensure such situations are avoided in future.

The project host management of the company, where the project is implemented, has to establish a communication channel that will make it possible to submit suggestions, improvement proposals and project ideas for more accurate future monitoring for every person involved in the monitoring activities. All communications will be delivered to the project host management who is required to review these communications and in case it is found appropriate implement necessary corrective actions and improvements. "AGS-2008" LLC will conduct periodic review of the monitoring plan and procedures and if necessary will propose changes to improve control of certain indicators.

Procedures that will be implemented if expected data from any sources are not available

For data and parameters, monitoring of which is not made during the whole crediting period, and the values are determined only once (and remain unchanged during the whole crediting period) and are available or unavailable at the stage of determination of the PDD, the values indicated in the PDD are used. If updated data are not available, last publicly available actual values are used. If any data are not available for calculations GHG emissions data of the previous period are used.

For data and parameters, which are monitored during the whole crediting period, standard procedures in this sector for each data type are used. For example cross-checking with suppliers, receiving estimated values, averaging etc. In each case, changing the method of receiving data will be recorded and displayed in the monitoring report.

Emergency preparedness for cases where emergencies can cause unintended emissions



During operation of the project it is impossible to predict all factors and emergency situations that can cause unintended GHG emissions. Safe operation of equipment and personnel is ensured by systematic training on security. Procedures for dealing with general emergencies such as fire, major malfunctions etc. are developed as part of the mandatory business regulations and are in accordance with local requirements.

Compliance with the standard procedures used in the relevant field.

Used monitoring procedure corresponds to the standard procedures for projects of this type and common practice in the field. Following monitoring plans of the projects can be given as an example of the standard monitoring procedures: UA2000020 Waste heaps dismantling with the aim of decreasing the greenhouse gases emissions into the atmosphere⁵⁵; UA2000034 Processing of Waste Heaps at “Monolith-Ukraine”⁵⁶. The monitoring approach in this project is fully consistent with the standards in the field and includes monitoring of the amount of coal, extracted from the waste heap, the amount of fuel, consumed by the project activity, and the amount of electricity, consumed under the project. Additional monitoring parameters (ash and water content of coal is removed from the waste heap, emission factors, etc.) serve to improve the accuracy of monitoring and correspond to the applied approach to determining the baseline and monitoring in the project.

D.1.1. Option 1 – Monitoring of the emissions in the project scenario and the baseline scenario:

This section is left blank on purpose.

D.1.1.1. Data to be collected in order to monitor emissions from the project, and how these data will be archived:								
ID number <i>(Please use numbers to ease cross-referencing to D.2.)</i>	Parameters	Source of data	Data unit	Measured (m), calculated (c), estimated (e)	Recording frequency	Proportion of data to be monitored	How will the data be archived? (electronic/paper)	Comment

⁵⁵http://ji.unfccc.int/JI_Projects/DB/VOZK3HERSNQGFLCY0YZ3AX5W676M5R/Determination/Bureau%20Veritas%20Certification1277814730.41/viewDeterminationReport.html

⁵⁶http://ji.unfccc.int/JI_Projects/DB/IPT7L3CLGIZTGGX27T2101W7XCUCWW/Determination/DNV-CUK1315829182.27/viewDeterminationReport.html



P-1	$EC_{PJ,y}$ - Amount of electricity, consumed as a result of the project activity in the relevant period y	Acceptance certificates of consumed electricity. Indications of electricity meters	MWh	m	Monthly	100%	Electronic and paper	Data will be archived during 2 years after the last transfer of ERUs to the buyer
P-2	$FC_{PJ,Diesel,y}$ - Amount of diesel fuel that was consumed by transport as a result of the project activity in the relevant period y	Company records	t	c	Monthly	100%	Electronic and paper	Data will be archived during two years after the last transfer of ERUs to the buyer
P-3	$EF_{grid,y}$ - Specific indirect carbon dioxide emissions from electricity consumption by electricity consumers, related to the relevant period y	See Section D.1.	tCO ₂ /MWh	e	Fixed ex-ante	100%	Electronic and paper	Last updated specific data available at the time of determination, verification
P-4	$NCV_{Diesel,y}$ - Net calorific value of diesel fuel in period y	National Inventory Report of Ukraine 1990-2010 (value for mobile combustion, off-road transportation)	TJ/kt	e	Fixed ex-ante	100%	Electronic and paper	Last updated specific data available at the time of determination, verification
P-5	$OXID_{Diesel,y}$ - Carbon oxidation factor of diesel fuel in period y	National Inventory Report of Ukraine 1990-2010 (value for mobile combustion, off-road transportation)	ratio	e	Fixed ex-ante	100%	Electronic and paper	Last updated specific data available at the time of determination, verification



P-6	$k_{Diesel,y}^C$ - Carbon content of diesel fuel in period y	National Inventory Report of Ukraine 1990-2010 (value for mobile combustion, off-road transportation)	t C/TJ	e	Fixed ex-ante	100%	Electronic and paper	Last updated specific data available at the time of determination, verification
-----	----------------------------------------------------------------	-------------------------------------------------------------------------------------------------------	--------	---	---------------	------	----------------------	---------------------------------------------------------------------------------

D.1.1.2. Description of formulae used to estimate project emissions (for each gas, source etc.; emissions in units of CO₂ equivalent):

Calculation results are presented in metric tons of carbon dioxide equivalent (tCO₂e), 1 metric ton of carbon dioxide equivalent is equal to 1 metric ton of carbon dioxide (CO₂), i.e. 1 tCO₂e = 1 tCO₂.

Project GHG emissions are calculated as follows:

$$PE_y = PE_{EL,y} + PE_{Diesel,y}, \quad (\text{Equation 7}),$$

where:

PE_y - Project emissions due to project activity in period y , tCO₂e;

$PE_{EL,y}$ - Project emissions due to consumption of electricity from the grid by the project activity in period y , tCO₂e;

$PE_{Diesel,y}$ - Project emissions due to consumption of diesel fuel by the project activity in period y , tCO₂e.

Project emissions due to consumption of electricity from the grid by the project activity are calculated as follows:

$$PE_{EL,y} = EC_{PJ,y} \cdot EF_{grid,y}, \quad (\text{Equation 8}),$$

where:

$EC_{PJ,y}$ - Amount of electricity, consumed as a result of the project activity in the relevant period y , MWh;

$EF_{grid,y}$ - Specific indirect carbon dioxide emissions from electricity consumption by 2nd class electricity consumers in accordance with Procedure for determining the class of consumers, adopted by Resolution of National Electricity Regulatory Commission of Ukraine on 13 of August 1998 No.1052, tCO₂/MWh.



Project emissions due to consumption of diesel fuel by the project activity are calculated as follows:

$$PE_{Diesel,y} = \frac{FC_{PJ,Diesel,y}}{1000} \cdot NCV_{Diesel,y} \cdot OXID_{Diesel,y} \cdot k_{Diesel,y}^C \cdot \frac{44}{12}, \quad (\text{Equation 9}),$$

where:

$FC_{PJ,Diesel,y}$ - Amount of diesel fuel consumed as a result of the project activity in period y , t;

$NCV_{Diesel,y}$ - Net calorific value of diesel fuel, TJ/kt;

$OXID_{Diesel,y}$ - Carbon oxidation factor of diesel fuel in period y , ratio;

$k_{Diesel,y}^C$ - Carbon content of diesel fuel in period y , t C/TJ;

$\frac{44}{12}$ - Ration between molecular mass of CO₂ and C. Reflect oxidation of C to CO₂.

D.1.1.3. Relevant data necessary for determining the <u>baseline</u> of anthropogenic emissions of greenhouse gases by sources within the project boundary, and how such data will be collected and archived:								
ID number (Please use numbers to ease cross-referencing to D.2.)	Parameters	Source of data	Data unit	Measured (m), calculated (c), estimated (e)	Recording frequency	Proportion of data to be monitored	How will the data be archived? (electronic/ paper)	Comment



B-1	$FR_{Coal,y}$ - Amount of coal product, received by enrichment of carbonaceous rock as a result of project activity in the relevant period y	Commercial data of the company. Weighing is implemented using special scales.	t	m/c	Continuously	100%	Electronic and paper	Data will be archived during 2 years after the last transfer of ERUs to the buyer
B-2	$A_{enrich,y}$ - Average ash content of enriched coal extracted from the waste heaps in the relevant period y	Results of the study of coal samples	%	m/c	Annually	100%	Electronic and paper	Data will be archived during 2 years after the last transfer of ERUs to the buyer
B-3	$W_{enrich,y}$ - Average water content of enriched coal extracted from the waste heaps in the relevant period y	Results of the study of coal samples	%	m/c	Annually	100%	Electronic and paper	Data will be archived during 2 years after the last transfer of ERUs to the buyer
B-4	$FC_{BE,Coal,y}$ - Amount of coal that would be mined in the baseline scenario and consumed in the energy sector for energy production in the relevant period y	Data of the company	t	c	Monthly	100%	Electronic and paper	Calculated under equation "3" in Section B.1.
B-5	$A_{coal,y}$ - Average ash content of thermal coal extracted in Lugansk region, Ukraine in period y	See Annex 4	%	m	Fixed ex-ante	100%	Electronic and paper	Statistical data Are available at the time of determination, verification data



B-6	$W_{coal,y}$ - Average ash content of thermal coal extracted in Lugansk region, Ukraine in period y	See Annex 4	%	m	Fixed ex-ante	100%	Electronic and paper	Statistical data Are available at the time of determination, verification data
B-7	$NCV_{Coal,y}$ - Net Calorific Value of coal in period y	National Inventory Report of Ukraine 1990-2010 (1.A.1.a – Public Electricity and Heat Production)	TJ/kt	e	Fixed ex-ante	100%	Electronic and paper	Last updated specific data available at the time of determination, verification
B-8	$OXID_{Coal,y}$ - Carbon oxidation factor of coal in year y	National Inventory Report of Ukraine 1990-2010 (1.A.1.a – Public Electricity and Heat Production)	ratio	e	Fixed ex-ante	100%	Electronic and paper	Last updated specific data available at the time of determination, verification
B-9	$k_{Coal,y}^C$ - Carbon content of coal in period y	National Inventory Report of Ukraine 1990-2010 (1.A.1.a – Public Electricity and Heat Production)	T C/TJ	e	Fixed ex-ante	100%	Electronic and paper	Last updated specific data available at the time of determination, verification



B-10	P_{WHB} - Correction factor, determining the probability of spontaneous combustion of the waste heap	Report on the fire risk of Lugansk Region's waste heaps, Scientific Research Institute "Respirator", Donetsk, 2012	dimension less unit	e	Fixed ex-ante	100%	Electronic and paper	Last updated specific data available at the time of determination, verification
------	--------------------------------------------------------------------------------------------------------	--------------------------------------------------------------------------------------------------------------------	---------------------	---	---------------	------	----------------------	---------------------------------------------------------------------------------

D.1.1.4. Description of formulae used to estimate baseline emissions (for each gas, source etc.; emissions in units of CO₂ equivalent):

Calculation results are presented in metric tons of carbon dioxide equivalent (tCO₂e), 1 metric ton of carbon dioxide equivalent is equal to 1 metric ton of carbon dioxide (CO₂), i.e. 1 tCO₂e = 1 tCO₂.

Baseline emissions are calculated as follows:

$$BE_y = BE_{WHB,y} \quad (\text{Equation 10}),$$

where:

BE_y - Baseline emissions in period y , tCO₂e;

$BE_{WHB,y}$ - Baseline emissions related to waste heap burning in period y , tCO₂e.

Baseline emissions related to waste heaps combustion are calculated as:

$$BE_{WHB} = \frac{FC_{BE,Coal,y}}{1000} \cdot p_{WHB} \cdot NCV_{Coal,y} \cdot OXID_{Coal,y} \cdot k_{Coal,y}^C \cdot \frac{44}{12}, \quad (\text{Equation 11}),$$

where:

$FC_{BE,Coal,y}$ - Amount of coal that would be mined in the baseline scenario and consumed in the energy sector for energy production in the relevant period y , t;



- ρ_{WHB} - Correction factor, determining the probability of spontaneous combustion of the waste heap, dimensionless unit;
 $NCV_{Coal,y}$ - Net calorific value of coal in period y , TJ/kt;
 $OXID_{Coal,y}$ - Carbon oxidation factor of coal in period y , ratio;
 $k_{Coal,y}^C$ - Carbon content of coal in period y , tC/TJ;
 $\frac{44}{12}$ - Ration between molecular mass of CO_2 and C. Reflect oxidation of C to CO_2 ;
 $1/1000$ - Physical transformation [t] in [kt] for calculation convenience.

Amount of coal that would be mined in the baseline scenario and burned for energy production is calculated by the formula:

$$FC_{BE,coal,y} = FR_{coal,y} \cdot \frac{\left(1 - \frac{A_{enrich,y}}{100} - \frac{W_{enrich,y}}{100}\right)}{\left(1 - \frac{A_{coal,y}}{100} - \frac{W_{coal,y}}{100}\right)} \quad (\text{Equation 12}),$$

where:

- $FR_{coal,y}$ - Amount of coal product, received by enrichment of carbonaceous rock as a result of project activity in the relevant period y , t;
 $A_{enrich,y}$ - Average ash content of enriched coal of energy class, extracted from the waste heaps as a result of the project activity in period y , %;
 $W_{enrich,y}$ - Average water content of enriched coal of energy class, extracted from the waste heaps as a result of the project activity in period y , %;
 $A_{coal,y}$ - Average ash content of thermal coal produced in the Lugansk region of Ukraine in period y , %;
 $W_{coal,y}$ - Average ash content of thermal coal produced in the Lugansk region of Ukraine in period y , %;
 $1/100$ - Mathematical transformation into fraction, relative unit.



D.1.2. Option 2 – Direct monitoring of emission reductions from the project (values should be consistent with those in section E.):

This section is left blank on purpose.

D.1.2.1. Data to be collected in order to monitor emission reductions from the <u>project</u>, and how these data will be archived:								
ID number <i>(Please use numbers to ease cross-referencing to D.2.)</i>	Parameter	Source of data	Data unit	Measured (m), calculated (c), estimated (e)	Recording frequency	Proportion of data to be monitored	How will the data be archived? (electronic/ paper)	Comment

This section is left blank on purpose.

D.1.2.2. Description of formulae used to calculate emission reductions from the project (for each gas, source etc.; emissions/emission reductions in units of CO₂ equivalent):

This section is left blank on purpose.

D.1.3. Treatment of leakage in the monitoring plan:

This project will result in a net change in fugitive methane emissions due to the mining activities. As coal in the baseline scenario is only coming from mines it causes fugitive emissions of methane. These are calculated as standard country specific emission factor applied to the amount of coal that is extracted from the waste heaps in the project scenario (which is equivalent to the same as the amount of coal that would have been mined in the baseline scenario). Also, the project takes into account other sources which are observed in the operation of coal mines, namely, electricity consumption from the grid of Ukraine. Coal mines consume large amounts of electricity, so these emissions should be considered. This leakage is significant and will be included in the monitoring plan and calculation of the project emission reductions.



D.1.3.1. If applicable, please describe the data and information that will be collected in order to monitor leakage effects of the project:								
ID number (Please use numbers to ease cross-referencing to D.2.)	Parameter	Source of data	Data unit	Measured (m), calculated (c), estimated (e)	Recording frequency	Proportion of data to be monitored	How will the data be archived? (electronic/paper)	Comment
L-1	$FR_{Coal,y}$ - Amount of coal product, received by enrichment of carbonaceous rock as a result of project activity in the relevant period y	Commercial data of the company. Determined by weighing on special scales	t	m/c	continuously	100%	Electronic and paper	Data will be archived during two years after the last transfer of ERUs to the buyer
L-2	$FC_{BE,Coal,y}$ - Amount of coal that would be mined in the baseline scenario and consumed in the energy sector for energy production in the relevant period y	Data of the company	t	c	monthly	100%	Electronic and paper	Calculated under equation "3" in Section B.1.
L-3	GWP_{CH_4} - Global warming potential of Methane	See Section D.1.	tCO ₂ e/ tCH ₄	e	Fixed ex-ante	100%	Electronic and paper	Are available at the time of determination, verification data
L-4	$N^e_{coal,y}$ - Average electricity consumption per ton of coal, produced in	See Section D.1.	MWh/t	e	Fixed ex-ante	100%	Electronic and paper	Last updated specific data available at the time of

This template shall not be altered. It shall be completed without modifying/adding headings or logo, format or font.



	Ukraine in period y							determination, verification
L-5	ρ_{CH_4} - Methane density under standard conditions	See Section D.1.	t/m^3	e	Fixed ex-ante	100%	Electronic and paper	Are available at the time of determination, verification data
L-6	$EF_{CH_4,CM}$ - Fugitive methane emissions factor during coal mines operation in period y	See Section D.1.	m^3/t	e	Fixed ex-ante	100%	Electronic and paper	Last updated specific data available at the time of determination, verification
L-7	$EF_{grid,y}$ - Specific indirect carbon dioxide emissions from electricity consumption by 2 nd class electricity consumers in the relevant period y	See Section D.1.	tCO_2/MWh	e	Fixed ex-ante	100%	Electronic and paper	Last updated specific data available at the time of determination, verification

Parameters given in Sections D.1.1.1, D.1.1.2, D.1.3.1, and are determined ex-ante, are collected by using publicly available sources, which are periodically updated. Such sources are National Inventory Report of Ukraine 1990-2010, and also IPCC Guidelines.

D.1.3.2. Description of formulae used to estimate leakage (for each gas, source etc.; emissions in units of CO₂ equivalent):

Leakages in period y are calculated as follows:

$$LE_y = LE_{CH_4,y} + LE_{EL,y} \quad (Equation 13),$$

where:

This template shall not be altered. It shall be completed without modifying/adding headings or logo, format or font.



LE_y - Leakages as a result of the project implementation in period y , tCO₂e;

$LE_{CH_4,y}$ - Leakages related to fugitive emissions of methane during operation of mines in period y , tCO₂e;

$LE_{EL,y}$ - Leakages related to electricity consumption during operation of mines in period y , tCO₂e.

Leakages related to fugitive emissions of methane during operation of mines in period y are calculated as follows:

$$LE_{CH_4,y} = -FC_{BE,Coal,y} \cdot EF_{CH_4,CM} \cdot \rho_{CH_4} \cdot GWP_{CH_4} \quad (\text{Equation 14}),$$

where:

$FC_{BE,Coal,y}$ - Amount of coal that would be mined in the baseline scenario and consumed in the energy sector for energy production in the relevant period y , t;

$EF_{CH_4,CM}$ - Fugitive methane emissions factor during coal mining, m³/t;

ρ_{CH_4} - Methane density, t/ m³;

GWP_{CH_4} - Global warming potential of methane, tCO₂e/tCH₄.

Amount of coal, mined in the baseline scenario and consumed in the energy sector for energy production in the relevant period is calculated under the equation “3” of Section B.1.

Leakages related to electricity consumption from energy grid during coal mining in period y are calculated as follows:

$$LE_{EL,y} = -FC_{BE,Coal,y} \cdot N^{e,coal,y} \cdot EF_{grid,y} \quad (\text{Equation 15}),$$

where:

$FC_{BE,coal,y}$ - Amount of coal that would be mined in the baseline scenario and consumed in the energy sector for energy production in the relevant period y , t;

$N^{E,coal,y}$ - Average electricity consumption per ton of coal, produced in Ukraine in period y , MWh/t;

$EF_{grid,y}$ - Specific indirect carbon dioxide emissions from electricity consumption by 2nd class electricity consumers, t CO₂/MWh.

This template shall not be altered. It shall be completed without modifying/adding headings or logo, format or font.



D.1.4. Description of formulae used to estimate emission reductions for the project (for each gas, source etc.; emissions/emission reductions in units of CO₂ equivalent):

Annual emission reductions are calculated as follows:

$$ER_y = BE_y - PE_y - LE_y \quad \text{(Equation 16),}$$

where:

ER_y – Emission reductions as a result of the project implementation in period y , tCO₂e;

BE_y – Emissions in baseline scenario in period y , tCO₂e;

PE_y – Project emissions as a result of the project implementation in period y , tCO₂e;

LE_y – Leakages as a result of the project implementation in period y , tCO₂e.

D.1.5. Where applicable, in accordance with procedures as required by the host Party, information on the collection and archiving of information on the environmental impacts of the project:

Collection and archiving of the information on the environmental impacts of the project will be done based on the approved EIA in accordance with the Host Party legislation – *State Construction Standard DBN A.2.2.-1-2003: “Structure and Contents of the Environmental Impact Assessment Report (EIA) for Designing and Construction of Production Facilities, Buildings and Structures”* State Committee Of Ukraine On Construction And Architecture, 2004 (see Section F.1).

D.2. Quality control (QC) and quality assurance (QA) procedures undertaken for data monitored:

Data (Indicate table and ID number)	Uncertainty level of data (high/medium/low)	Explain QA/QC procedures planned for these data, or why such procedures are not necessary.
D.1.1.1. – P-1	Low	The electricity meters are calibrated according to the procedures of the Host Party. Calibration interval is – 6 years.
D.1.1.1. – P-2	Low	This parameter comes from the contractor in the form of certificates of completion. Data are archived in paper and electronic form.
D.1.1.1. – P-3	Low	This parameter is provided by DFP of Ukraine annually. If the value of coefficient is not available at the time of determination or verification, the value for the previous year is taken into calculations.

This template shall not be altered. It shall be completed without modifying/adding headings or logo, format or font.



D.1.1.1. – P-4 - P-6	Low	Values of these parameters are taken according to the most actual source - National Inventory Report of Ukraine
D.1.1.3. – B-1	Low	This parameter is used in the commercial activity of community. This parameter is determined by weighing cargo on special automobile scales that are calibrated according to the procedures of the Host party. The interval between calibration is one year.
D.1.1.3. – B-2	Low	This parameter is used in the commercial activity of the company. Laboratory research
D.1.1.3. – B-3	Low	This parameter is used in the commercial activity of the company. Laboratory research
D.1.1.3. – B-4	Low	This parameter is calculated according to equation (3) of this PDD.
D.1.1.3. – B-5 – B-6	Low	These parameters are determined in accordance with Guide of quality, volume of coal production and enrichment products in 2008-2010, Ministry of Coal Industry of Ukraine, State Committee of Ukraine. This source provides clear and transparent information
D.1.1.3. – B-7 – B-9	Low	Values of these parameters are taken according to the most actual source - National Inventory Report of Ukraine
D.1.1.3. – B-10	Low	Actual research of Scientific Research Institute “Respirator”
D.1.3.1. – L-1	Low	This parameter is used in the commercial activity of community. This parameter is determined by weighing cargo on special automobile scales that are calibrated according to the procedures of the Host party. The interval between calibration is one year.
D.1.3.1. – L-2	Low	This parameter is calculated according to equation (3) of this PDD.
D.1.3.1. – L-3	Low	International generally accepted values provided by IPCC are used
D.1.3.1. – L-4	Low	Actual statistic data for country that are provided by the body of State Committee of Ukraine
D.1.3.1. – L-5	Low	International generally accepted values provided by IPCC are used
D.1.3.1. – L-6	Low	Value of this parameter is taken according to the most actual source - National Inventory Report of Ukraine
D.1.3.1. – L-7	Low	This parameter is provided by DFP of Ukraine annually. If the value of coefficient is not available at the time of determination or verification, the value for the previous year is taken into calculations.

D.3. Please describe the operational and management structure that the project operator will apply in implementing the monitoring plan:

The project owner, which will implement the provisions of this monitoring plan in the structure of organization and quality management, is “AGS-2008” LLC. Stages of collecting information, generating reports, storing monitoring data are performed by different responsible persons and departments, and then sent to the Director of “AGS-2008” LLC, which has overall responsibility for monitoring. Detailed structure of the administrative board of the company will be established in Monitoring report before the primary and the first verification. The basic structure is demonstrated by the following flowchart:

This template shall not be altered. It shall be completed without modifying/adding headings or logo, format or font.

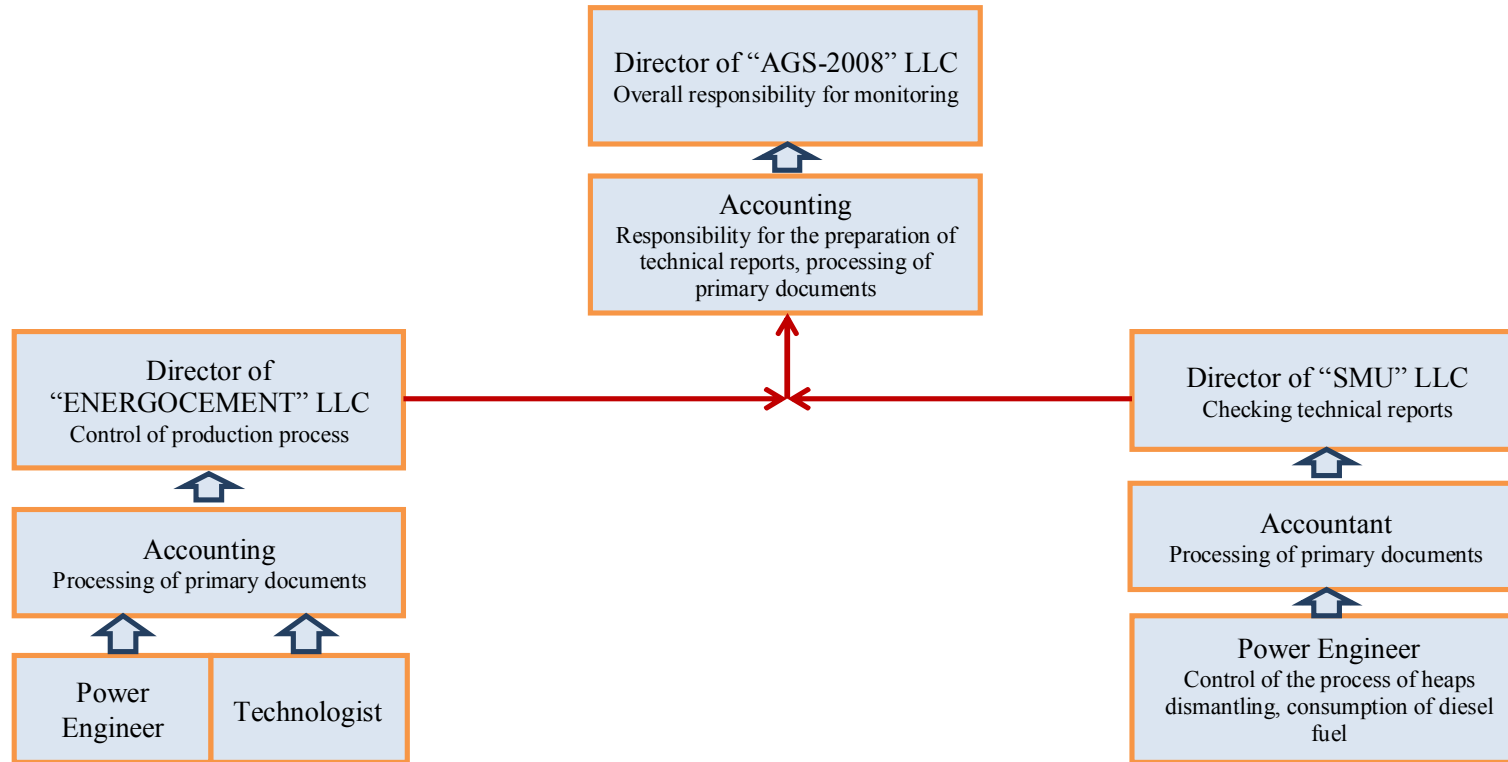

Figure 12 – Flowchart of monitoring.

The following management system acts at “AGS-2008” LLC:

1. Director of “AGS-2008” LLC is the main figure in management structure of the enterprise. He is responsible for the accuracy and reliability of all monitoring indicators, provides cross checks of certain parameters used for calculation of GHG emission reductions. Strategy of development and planning of the project depends on his direct actions.



2. Accounting Department is responsible for collecting, archiving and visualization of monitoring parameters. This department carries out cross-checks on the number of shipped coal products with buyers; on the number of consumed fuel and consumed electricity with companies-contractors. Accounting forms monthly and annual technical reports and submit them to the Director of “AGS-2008” LLC.

The following management system acts at “SMU” LLC:

1. Director of “SMU” LLC is responsible for efficiency of work on waste heaps dismantling, as well as for clarity and transparency of information which is formed in the accounting reports. He controls the accounting documents, verifies their reliability and transmits the information to the accounting department of “AGS-2008” LLC.
2. Accountant is responsible for collection and archiving data on consumption of diesel fuel and the number of transported carbonaceous rock to the concentrating complex. He forms the writing off certificates of diesel fuel, spending bills, and transfers completion certificates with clear and precise information on the consumption under the project to the Director of “SMU” LLC.
3. Power Engineer controls the process of waste heaps dismantling, is responsible for safety and implementation of plan, appointed by management of the enterprise. He collects primary information on the consumption of diesel fuel (receipts, logs) and transmits them to the accounting department of “SMU” LLC. Besides, Power Engineer is responsible for the technical condition of spectechnique and cargo transport and the number of transported rock.

The following management system acts at “ENERGOCEMENT” LLC:

1. Director of “ENERGOCEMENT” LLC is fully responsible for course of the production process. He conducts revision of workplaces, monitors indicators of industrial productivity, and makes appropriate adjustments. He controls the accounting documents, which go to him, namely, amount of produced goods, amount of consumed electricity, etc.
2. Accounting Department is responsible for collecting, archiving and visualization of primary data on the amount of enriched coal, electricity consumption. Accounting is a buffer between production site and Director of the enterprise. This department is also responsible for periodic studies of coal samples that were extracted from the waste heap as a result of the project activity. He forms monthly and annual technical reports and submit them to the Director of “AGS-2008” LLC.
3. Power Engineer and Technologist are responsible for stable work of the concentrating complex, safety and control of measuring equipment. Power Engineer is responsible for timely calibration of electricity meters and automobile scales, safety in the operation of electrical equipment. All reports and recommendations on the project activity, he submits to the Director. Technologist is responsible for stable operation of all links of technological scheme of concentrating complex. He controls the percent of an exit of the final product and makes appropriate hardware settings in case of discrepancies in production program. Also Technologist works closely with the Power Engineer and submits appropriate recommendations on improving work of all technological equipment.



D.4. Name of persons/entities establishing the monitoring plan:

“AGS-2008” LLC is the owner of emission sources and a project participant. “AGS-2008” LLC is initiator of this project and developer of the project design documentation simultaneously. This company accompanies processes of receiving letter of support from SEIA, determination, receiving letter of approval from SEIA, registration, and verification of emission reductions achieved by the project “Carbonaceous rock processing and concentrating with the aim of reducing greenhouse gas emissions into the atmosphere”.

Contact details:

Company name:	“AGS-2008” LLC
Company address:	83013, Donetsk, Stepna Street, b. 151-A
<i>Contact person:</i>	
Name:	Zagorskiy Sergiy Igorovych
Title:	Director
Phone:	+38 (063) 397 11 02
Fax:	
E-mail:	ags2008.don@gmail.com

SECTION E. Estimation of greenhouse gas emission reductions
E.1. Estimated project emissions:

The formulas used to estimate the project anthropogenic emissions by sources of greenhouse gas emissions, description of calculations by these formulas and all the assumptions used are described in Section D.1.1.2.

Project emission	Unit	2009	2010	2011	2012	Total
Project emissions due to consumption of electricity from the grid as a result of the project activity in period <i>y</i>	tCO ₂ e	1 654	3 158	3 333	3 068	11 213
Project emissions due to consumption of diesel fuel as a result of the project activity in period <i>y</i>	tCO ₂ e	305	630	694	662	2 291
Total project emissions over the crediting period	tCO ₂ e	1 959	3 788	4 027	3 730	13 504

Table 21 – Estimated project emissions during the crediting period for 2009-2012.

Project emission estimated for 2013	Unit	Values of GHG emissions	Total
Project emissions due to consumption of electricity from the grid as a result of the project activity in period <i>y</i>	tCO ₂ e	2 699	2 699
Project emissions due to consumption of diesel fuel as a result of the project activity in period <i>y</i>	tCO ₂ e	556	556
Total project emissions after the crediting period	tCO ₂ e	3 255	3 255

Table 22 – Estimated project emissions after the crediting period for 2013.

E.2. Estimated leakage:

The formulas used to estimate the leakage under the project activities, description of calculations by these formulas and all the assumptions used are described in Section D.1.3.

Leakages	Unit	2009	2010	2011	2012	Total
Leakages due to fugitive emissions of methane in the mining activities in the period <i>y</i>	tCO ₂ e	-53 364	-101 348	-108 526	-105 967	-369 205
Leakages as a result of electricity consumption during coal mining in period <i>y</i>	tCO ₂ e	-16 540	-31 830	-31 044	-30 312	-109 726



Total leakages during the crediting period	tCO ₂ e	-69 904	-133 178	-139 570	-136 279	-478 931
---------------------------------------------------	--------------------	---------	----------	----------	----------	-----------------

Table 23 – Estimated leakages during the crediting period for 2009-2012

Leakages estimated for 2013	Unit	Values of GHG emissions	Total
Leakages due to fugitive emissions of methane in the mining activities in period y	tCO ₂ e	-84 774	-84 774
Leakages as a result of electricity consumption during coal mining in period y	tCO ₂ e	-24 249	-24 249
Total leakages after the crediting period	tCO ₂ e	-109 023	-109 023

Table 24 – Estimated leakages after the crediting period for 2013.

E.3. The sum of E.1. and E.2.:

Parameter	Unit	2009	2010	2011	2012	Total
Total project emissions during the crediting period	tCO ₂ e	-67 945	-129 390	-135 543	-132 549	-465 427

Table 25 – Estimated total emissions as a result of the project activity during the crediting period for 2009-2012.

Parameter	Unit	Values of GHG emissions	Total
Total project emissions after the crediting period	tCO ₂ e	-105 768	-105 768

Table 26 – Estimated total project emissions after crediting period for 2013.

E.4. Estimated baseline emissions:

Baseline emissions	Unit	2009	2010	2011	2012	Total
Baseline emissions due to burning of the waste heap in period y	tCO ₂ e	230 380	433 408	464 105	453 161	1 581 054
Total baseline emissions over the crediting period	tCO ₂ e	230 380	433 408	464 105	453 161	1 581 054

Table 27– Estimated baseline emissions during the crediting period for 2009-2012.

Baseline emissions estimated for 2013	Unit	Values of GHG emissions	Total
---------------------------------------	------	-------------------------	-------



Total baseline emissions after the crediting period related to burning of the waste heap in period y	tCO ₂ e	362 530	362 530
-------------------------------------------------------------------------------------------------------------	--------------------	---------	----------------

Table 28 – Estimated baseline emissions after the crediting period for 2013.

E.5. Difference between E.4. and E.3. representing the emission reductions of the project:

Parameter	Unit	2009	2010	2011	2012	Total
Emission reductions during the crediting period	tCO ₂ e	298 325	562 798	599 648	585 710	2 046 481

Table 29 – Estimated emission reductions during the crediting period for 2009-2012.

Emission reductions estimated for 2013	Unit	Values of annual GHG emissions	Total
Emission reductions after the crediting period	tCO ₂ e	468 298	468 298

Table 30 – Estimated emission reductions after the crediting period for 2013.

**E.6. Table providing values obtained when applying formulae above:**

Year	Estimated Project Emissions (tonnes CO ₂ equivalent)	Estimated Leakage (tonnes CO ₂ equivalent)	Estimated Baseline Emissions (tonnes CO ₂ equivalent)	Estimated Emissions Reductions (tonnes CO ₂ equivalent)
Year 2009	1 959	-69 904	230 380	298 325
Year 2010	3 788	-133 178	433 408	562 798
Year 2011	4 027	-139 570	464 105	599 648
Year 2012	3 730	-136 279	453 161	585 710
Total (tonnes CO ₂ equivalent)	13 504	-478 931	1 581 054	2 046 481

Table 31 – Estimated balance of emissions under the proposed project over the crediting period

Year	Estimated Project Emissions (tonnes CO ₂ equivalent)	Estimated Leakage (tonnes CO ₂ equivalent)	Estimated Baseline Emissions (tonnes CO ₂ equivalent)	Estimated Emissions Reductions (tonnes CO ₂ equivalent)
Year 2013	3 255	-109 023	362 530	468 298
Total (tonnes CO ₂ equivalent)	3 255	-109 023	362 530	468 298

Table 32 – Estimated balance of emissions under the proposed project after the crediting period

**SECTION F. Environmental impacts****F.1. Documentation on the analysis of the environmental impacts of the project, including transboundary impacts, in accordance with procedures as determined by the host Party:**

The Host Party for this project is Ukraine. Environmental Impact Assessment (EIA) is the part of the Ukrainian project planning and permitting procedures. Implementation regulations for EIA are included in the Ukrainian State Construction Standard DBN A.2.2.-1-2003⁵⁷ (Title: “Structure and Contents of the Environmental Impact Assessment Report (EIR) for Designing and Construction of Production Facilities, Buildings and Structures”).

In Annex F of this standard there is a list of “types of projects or activities that are of high environmental hazard” for which full-scale EIA is obligatory, Ministry of Environment and Natural Resources of Ukraine is competent authority for performing of it. Project activities that consist of utilization of wastes of coal industry and of coal production are included in this list.

Comprehensive EIA according to the legislation of Ukraine was performed for the proposed project in 2007 by Scientific Research Production and Commercial Firm “CER “Eko-Tera Ukraine” LLC. Here are some general conclusions of this EIA:

- The main impact of the project activity on the environment is the impact on air. Additional amount of coal dust and dust of coal concentrate will be released to the atmosphere as a result the project activity. However, the study of emission levels and pollutant distribution schemes show that during the project lifetime maximum concentration boundaries will not be exceeded. Fugitive emissions of dust and hazardous substances from the waste heap can also be avoided;
- Impact on water is insignificant. During the project activity water will be used in a closed cycle without draining wastewater. For replenishment of water cycle drainage water from a nearby mine will be used. Thus discharge of this water (treated with chlorine) into the environment will be reduced;
- Impact on flora and fauna is mixed. As a result of the project activity the existing landscape will change, but the aggregate final effect is positive. Grass and trees will be planted on the recultivated land. Rare or endangered species will avoid impact. Place of the project activity implementation is not located near national parks or areas that are protected;
- Noise impact is limited. The main source of noise will be at the minimum desired distance from residential areas, mobile sources as for noise (traffic) provisions of local standards will be met;
- Impact on land use is positive. Considerable areas of land will be exempt from waste heaps and available for building;
- There are no transboundary effects. There are no impacts which occur on the territory of any other country, and which are caused by the implementation of this project that is physically located entirely within Ukraine.

⁵⁷ State Construction Standard DBN A.2.2.-1-2003: “Structure and Contents of the Environmental Impact Assessment Report (EIR) for Designing and Construction of Production Facilities, Buildings and Structures” State Committee Of Ukraine On Construction And Architecture, 2004



F.2. If environmental impacts are considered significant by the project participants or the host Party, please provide conclusions and all references to supporting documentation of an environmental impact assessment undertaken in accordance with the procedures as required by the host Party:

Comprehensive EIA was performed in 2007 by Scientific Research Production and Commercial Firm “CER “Eko-Tera Ukraine” LLC. This study was focused on the impact of waste heaps dismantling on the environment. Conclusions of the report are above in section F.1. Project impact on the environment is not significant and harmful. According to Ukrainian laws and regulations, preparation of reports from Environmental Impact Assessment and positive conclusions of State Department of Ecology and Natural Resources makes procedure of environmental impact assessment.

**SECTION G. Stakeholders' comments****G.1. Information on stakeholders' comments on the project, as appropriate:**

No stakeholder consultation process for the JI projects is required by the Host Party. Stakeholder comments will be collected during the time of this PDD publication in the internet during the determination procedure. As a part of EIA, stakeholders must be informed via mass media about the proposed project as provided in *State construction standards of Ukraine DBN A.2.2.-1-2003: "Structure and Contents of the Environmental Impact Assessment (EIA) materials during design and construction of enterprises, buildings and structures"* issued by State Committee of Construction and Architecture in 2004. In accordance with the mentioned regulations, the relevant information was published in the local newspaper "Krasnodonskye vesti" (Krasnodon) # 66 (512) dated March 15, 2007 and # 78 (536) dated June 15, 2007. No comments were received.

Annex 1**CONTACT INFORMATION ON PROJECT PARTICIPANTS**

Organisation:	“AGS-2008” LLC
Street/P.O.Box:	Stepna Street
Building:	b. 151-A
City:	Donetsk
State/Region:	Donetsk
Postal code:	83013
Country:	Ukraine
Phone:	+38 (063) 397 11 02
Fax:	
E-mail:	AGS-20082008.don@gmail.com
URL:	-
Represented by:	Zagorskiy Sergiy Igorovych
Title:	Director
Salutation:	Mr.
Last name:	Zagorskiy
Middle name:	Igorovych
First name:	Sergiy
Department:	-
Phone (direct):	+38 (063) 397 11 02
Fax (direct):	
Mobile:	-
Personal e-mail:	AGS-20082008.don@gmail.com

Organisation:	ProEffect OÜ
Street/P.O.Box:	Türi
Building:	6
City:	Tallinn
State/Region:	
Postal code:	11313
Country:	Estonia
Phone:	+372 5102246
Fax:	-
E-mail:	-
URL:	pro.effect@live.com
Represented by:	Borys Kuznetsov
Title:	Board Member
Salutation:	Mr.
Last name:	Kuznetsov
Middle name:	-
First name:	Borys
Department:	-

This template shall not be altered. It shall be completed without modifying/adding headings or logo, format or font.



Phone (direct):	+372 5102246
Fax (direct):	-
Mobile:	-
Personal e-mail:	pro.effect@live.com

Annex 2**BASELINE INFORMATION***Description of parameters included in the baseline*

#	Parameter	Unit	Data source
1	$FC_{BE,Coal,y}$ - Amount of coal, mined in the baseline scenario and consumed in the energy sector for energy production in the relevant period y .	t	Calculated according to the equation (3), Section B.1. Documents of the project owner
2	$FR_{Coal,y}$ - Amount of coal product, received by enrichment of carbonaceous rock as a result of project activity in the relevant period y	t	Documents of the project owner
3	$A_{enrich,y}$ - Average ash content of enriched coal of energy class, extracted from the waste heaps as a result of the project activity in period y	%	Documents of the project owner. Laboratory study
4	$W_{enrich,y}$ - Average ash content of enriched coal of energy class, extracted from the waste heaps as a result of the project activity in period y	%	Documents of the project owner. Laboratory study
5	$A_{coal,y}$ - Average ash content of thermal coal extracted in Lugansk region, Ukraine in period y	%	Guide of quality, volume of coal production and enrichment products in 2008-2010, Ministry of Coal Industry of Ukraine, State Committee of Ukraine, and Lugansk 2010 (see Annex 4)
6	$W_{coal,y}$ - Average water content of thermal coal extracted in Lugansk region, Ukraine in period y	%	Guide of quality, volume of coal production and enrichment products in 2008-2010, Ministry of Coal Industry of Ukraine, State Committee of Ukraine, and Lugansk 2010 (see Annex 4)
7	$EF_{CH_4,CM}$ - Fugitive methane emissions factor during coal mines operation	m ³ /t	National Inventory Report of Ukraine 1990-2009 p. 90
8	p_{WHB} - Correction factor, determining the probability of spontaneous combustion of the waste heap	dimensionless unit	Report on the fire risk of Lugansk Region's waste heaps, Scientific Research Institute "Respirator", Donetsk, 2012
9	GWP_{CH_4} - Global Warming Potential of Methane	tCO ₂ e/ tCH ₄	IPCC Second Assessment Report



10	ρ_{CH_4} - Methane density	T/M^3	2006 IPCC Guidelines for National Greenhouse Gas Inventories, Volume 2: Energy, Chapter 4: Fugitive Emissions, Page 4.12. Value was converted from converted $Gg \cdot m^{-3}$ to t/m^3 . IPCC default value under standard physical conditions ($t=293,15$ K; $p=101,2325$ kPa)
11	$NCV_{Coal,y}$ - Net Calorific Value of coal in period y	TJ/kt	National Inventory Report of Ukraine 1990-2010
12	$OXID_{Coal,y}$ - Carbon Oxidation factor of coal in period y	ratio	National Inventory Report of Ukraine 1990-2010
13	$k_{Coal,y}^C$ - Carbon content of coal in period y	tC/TJ	National Inventory Report of Ukraine 1990-2010
14	$N^e_{coal,y}$ - Average electricity consumption per ton of coal, produced in Ukraine in period y	MWh/t	State Statistics Service of Ukraine. Fuel and energy resources of Ukraine, Statistical Yearbook, Kyiv 2009, State Statistics Service of Ukraine. Fuel and energy resources of Ukraine, Statistical Yearbook, Kyiv 2011. See also Annex 5
15	$EF_{grid,y}$ - Specific indirect carbon dioxide emissions from electricity consumption by 2 nd class electricity consumers in accordance with Procedure for determining the class of consumers, adopted by Resolution of National Electricity Regulatory Commission of Ukraine on 13 of August 1998 No.1052	tCO_2/MWh	National Environmental Investment Agency Orders: No.63 dated 15.04.2011 p. ⁵⁸ 2009 – 1.237 No.43 dated 28.03.2011 p. ⁵⁹ 2010 – 1.225 No.75 dated 12.05.2011 p. ⁶⁰ (2011 – 1.227; 2012 – 1.227 – the latest country-specific data) SEIA presents actual data of factor of indirect CO_2 emissions on an annual basis until March 1. If data are not available at the time of determination or verification, for GHG calculation value for the previous year is used.

⁵⁸ <http://www.neia.gov.ua/nature/doccatalog/document?id=127172>

⁵⁹ <http://www.neia.gov.ua/nature/doccatalog/document?id=126006>

⁶⁰ <http://www.neia.gov.ua/nature/doccatalog/document?id=127498>

Annex 3**MONITORING PLAN**

Monitoring plan is described in Section D of this PDD.

Measuring equipment used under the project:

ID	Parameter	Measuring device	Unit	Manufacturer	Type	Serial number	Accuracy class
EL	Electricity consumed	Electricity meter "Actaris SL7000 Smart"	kWh	Actaris ⁶¹	Multifunctional electronic electricity meter of type SL761B071	36128117	0,2s
W	Amount of coal	Automobile scales "BA-60CM"	t	ZKhO ⁶²	Tensometric automobile scales	511	20kg

⁶¹ <http://www.actaris.com.ua/rus/katalog/schetchik-Actaris-SL7000>

⁶² <http://www.ugmk.info/?company=1155197911&gr=1>



Annex 4

EXTRACTS FROM THE “REFERENCE BOOK OF QUALITY INDICATORS, VOLUME OF COAL PRODUCTION AND BENEFICIATION PRODUCTS IN 2008-2010”⁶³

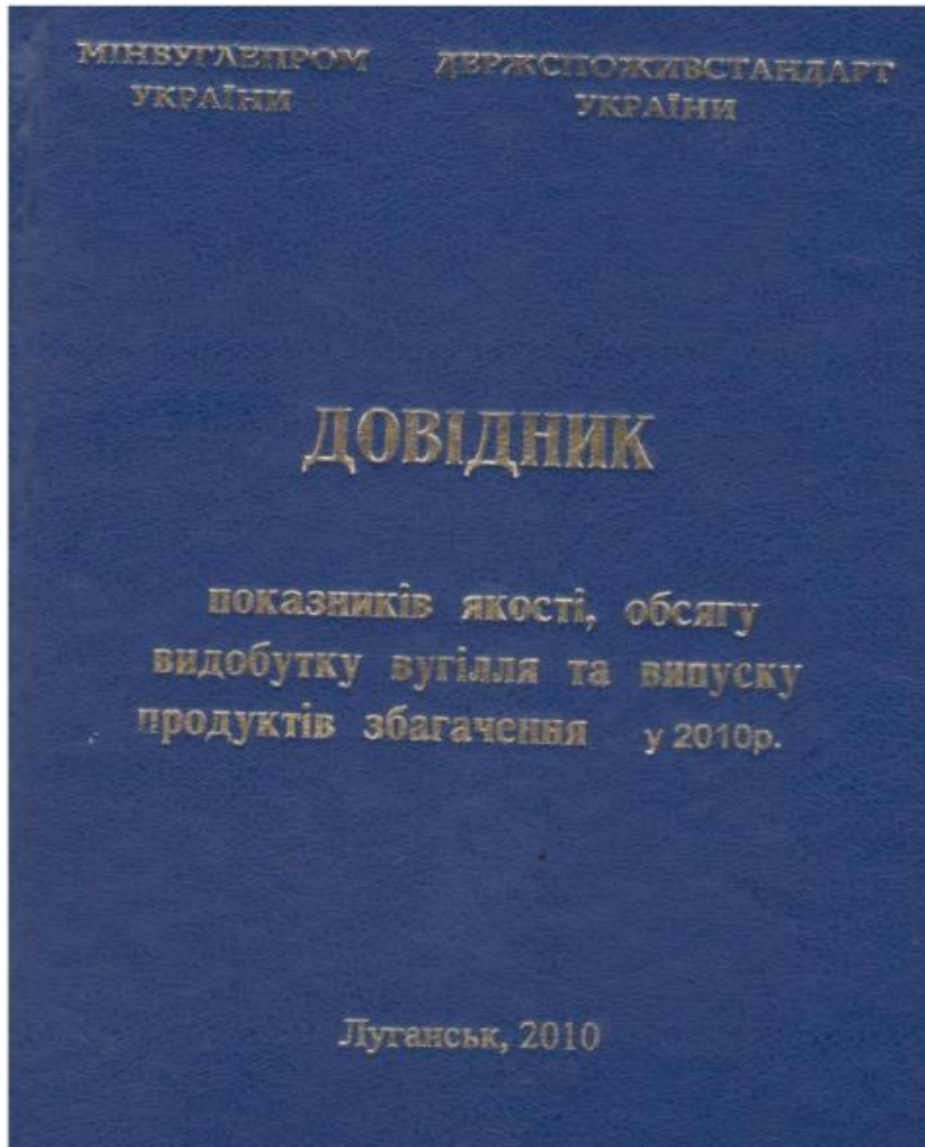

⁶³ <http://ji.unfccc.int/UserManagement/FileStorage/NMPXTGSA7E4C095DHRJYUWLOI8Z3V1>



Найменування шахти	Дільниця участі в видобутку вугілля по шахті у 2010 році, %	Марка вугілля ДСТУ 3472-06		Фактичний видобуток родового вугілля у 2009 році		Видобуток родового вугілля, що планується у 2010 році				Класифікаційні параметри			
		код	енерг.	тис. т	Зольність А ⁴ , %	тис. т	Зольність А ⁴ , %	Сірка S ² , %	Волога W ² , %	Середній показник вмісту азотистого R _n , %	Товщина пластинчатого шару Y, мм	Висота вентилі на суцільній стелі Y ² , %	Висота теплотворності Q _н ² , 8800 кДж/кг
МІНВУГЛЕПРОМ УКРАЇНИ				72522,5	38,6	76204,5	38,9	2,0	7,7	-	-	26,5	8166
у тому числі:													
<i>енергетичне вугілля</i>													
				50458,0	39,2	52135,8	38,9	2,0	8,2	-	-	24,5	8025
			Д	273,2	49,0	200,0	42,1	2,4	13,5	0,57	0	39,5	7487
			ДГ	13663,1	39,9	15455,7	39,4	1,7	11,7	0,58	8	41,5	8089
			Г	12929,9	42,5	12775,1	41,4	2,7	7,6	0,77	12	38,4	7586
			Ж	435,1	35,3	316,0	43,0	3,3	4,0	0,88	23	36,1	8365
			П	7806,1	35,2	8303,0	36,4	2,8	5,5	2,43	0	8,4	8520
			А	15350,6	37,6	15086,0	37,7	1,3	6,6	4,55	0	3,7	8059
<i>коксівне вугілля</i>													
				22064,5	37,2	24068,7	39,0	2,1	6,7	-	-	30,9	8470
			ДГ	567,4	32,8	53,3	33,2	1,2	10,2	0,61	9	39,6	8210
			Г	2855,0	34,9	4532,7	36,1	2,2	6,9	0,77	14	38,3	8364
			Ж	8388,1	37,5	9807,7	39,0	2,4	6,6	0,96	22	33,0	8383
			К	9430,9	38,1	8694,0	40,8	1,6	6,7	1,23	18	26,1	8605
			ПС	823,1	35,3	981,0	35,7	2,8	6,4	1,61	10	18,2	8650

Найменування шахти	Дільниця участі в видобутку вугілля по шахті у 2010 році, %	Марка вугілля ДСТУ 3472-06		Фактичний видобуток родового вугілля у 2009 році		Видобуток родового вугілля, що планується у 2010 році				Класифікаційні параметри			
		код	енерг.	тис. т	Зольність А ⁴ , %	тис. т	Зольність А ⁴ , %	Сірка S ² , %	Волога W ² , %	Середній показник вмісту азотистого R _n , %	Товщина пластинчатого шару Y, мм	Висота вентилі на суцільній стелі Y ² , %	Висота теплотворності Q _н ² , 8800 кДж/кг
Підпорядковані Мінвуглепрому				38398,0	39,6	39864,0	39,7	2,1	7,1	-	-	21,0	8133
у тому числі:													
<i>енергетичне вугілля</i>													
				31265,0	40,0	32171,0	40,0	2,1	7,2	-	-	19,4	8123
			Д	273,2	49,0	200,0	42,1	2,4	13,5	0,6	0	39,5	7487,0
			ДГ	2748,8	43,1	3205,0	41,2	2,6	9,9	0,61	8	40,6	7915
			Г	9645,4	43,6	10332,0	43,5	2,8	7,4	0,78	12	38,1	8174
			Ж	435,1	35,3	316,0	43,0	3,3	4,0	0,90	23	36,1	8365
			П	2811,9	36,8	3032,0	37,9	2,7	6,6	2,30	0	8,6	8503
			А	15350,6	37,6	15086,0	37,7	1,3	6,6	4,55	0	3,7	8059
<i>коксівне вугілля</i>													
				7130,5	37,8	6895,0	38,5	2,5	6,7	-	-	28,2	8523
			Г	1452,5	35,5	1360,0	37,0	1,8	6,6	0,80	14	36,6	8385
			Ж	2358,0	35,4	2150,0	37,2	2,6	6,8	1,02	21	32,4	8437
			К	2496,9	42,1	2404,0	41,7	2,7	6,7	1,33	21	23,6	8625
			ПС	823,1	35,3	981,0	35,7	2,8	6,4	1,61	10	18,2	8650
Непідпорядковані Мінвуглепрому				34127,0	37,4	37138,5	38,1	1,9	8,3	-	-	32,4	8136
у тому числі:													
<i>енергетичне вугілля</i>													
				19193,0	27,9	19964,8	37,2	1,9	9,8	-	-	32,7	7867
			ДГ	10914,3	39,0	12250,7	38,9	1,4	12,2	0,6	8	41,8	8135
			Г	3284,5	39,3	2443,1	32,5	2,6	8,3	0,7	11	39,6	5096
			П	4994,2	34,4	5271,0	35,5	2,8	4,9	2,5	0	8,3	8530
				14934,0	36,9	17173,7	39,1	2,0	6,7	-	-	32,0	8449
<i>коксівне вугілля</i>													
				567,4	32,8	53,3	33,2	1,2	10,2	0,6	9	39,6	8210
			ДГ	1402,5	34,3	3172,7	35,6	2,4	7,1	0,7	13	39,0	8355
			Г	6030,1	38,3	7657,7	39,5	2,3	6,5	0,9	22	33,1	8368
			Ж	6934,0	36,6	6290,0	40,5	1,3	6,7	1,2	18	27,0	8597
			К	34127,0	37,4	37138,5	38,1	1,9	8,3	-	-	32,4	8136



Найменування шахти	Дільова участь в видобутку вугілля на шахті у 2010 році, %	Марка вугілля ДСТУ 3472-06		Фактичний видобуток родового вугілля у 2009 році		Видобуток родового вугілля, що планується у 2010 році				Класифікаційні параметри				
		кокс	енерг.	тис. т	Залишність А ^с , %	тис. т	Залишність А ^с , %	Средн. S ^с , %	Волога W ^с , %	Середній показник міцності вугілля R _с , %	Товщина пластинчатого шару Y, мм	Витрати легкого нафтового масла на сухий стан у ^с , %	Витрати теплової енергії Q ^с , ккал/т	
Донецька область				32159,6	38,1	32038,5	38,3	2,3	6,9	-	-	25,6	8389	
у тому числі:														
Підприємства Міністерства				17919,6	40,0	18344,0	39,9	2,4	7,1	-	-	27,6	8307	
Непідприємства Міністерства				14240,0	35,6	13694,5	36,2	2,0	6,6	-	-	22,9	8499	
у тому числі:														
енергетичне вугілля				16921,1	39,5	18025,0	38,7	2,4	6,6	-	-	22,3	8294	
				Д	273,2	49,0	200,0	42,1	2,4	13,5	0,57	0	39,5	7487
				ДГ	1460,3	44,7	1575,0	41,8	2,6	8,7	0,63	8	41,2	8017
				Г	6431,7	42,1	6906,0	40,1	2,5	7,3	0,80	12	37,8	8194
				П	7074,8	35,1	7458,0	36,3	2,7	5,4	2,44	0	3,4	8519
				А	1681,1	42,3	1886,0	40,2	1,0	6,6	4,17	0	3,5	8091
коксівне вугілля				15238,5	36,4	14013,5	37,9	2,0	7,2	-	-	29,7	8511	
				Г	2037,5	35,1	1985,8	36,6	2,5	6,8	0,79	17	35,3	8408
				Ж	4497,7	34,6	4757,7	36,2	2,4	7,4	0,99	21	33,6	8476
				К	7944,3	37,9	6394,0	39,7	1,4	7,2	1,20	17	26,7	8551
				ПС	759,0	38,9	876,0	36,5	2,7	6,3	1,58	10	18,4	8643
Луганська область				23401,7	38,8	25802,0	39,3	2,1	6,9	-	-	17,6	7873	
у тому числі:														
Підприємства Міністерства України				17246,7	38,3	17502,0	38,4	1,9	7,3	-	-	11,1	8062	
Непідприємства Міністерства України				6155,0	40,4	8300,0	41,1	2,5	6,0	-	-	31,3	7473	

Найменування шахти	Дільова участь в видобутку вугілля на шахті у 2010 році, %	Марка вугілля ДСТУ 3472-06		Фактичний видобуток родового вугілля у 2009 році		Видобуток родового вугілля, що планується у 2010 році				Класифікаційні параметри				
		кокс	енерг.	тис. т	Залишність А ^с , %	тис. т	Залишність А ^с , %	Средн. S ^с , %	Волога W ^с , %	Середній показник міцності вугілля R _с , %	Товщина пластинчатого шару Y, мм	Витрати легкого нафтового масла на сухий стан у ^с , %	Витрати теплової енергії Q ^с , ккал/т	
у тому числі:														
енергетичне вугілля				17960,6	38,4	18347,0	38,1	1,9	7,4	-	-	12,7	7941	
				ДГ	812,5	43,1	1040,0	42,5	3,0	12,0	0,56	8	41,8	7792
				Г	2747,3	44,1	3262,0	40,1	3,7	9,2	0,66	11	40,7	8690
				П	731,3	36,7	845,0	36,7	3,3	6,7	2,36	0	9,0	8531
				А	13669,5	37,1	13200,0	37,3	1,4	6,6	4,61	0	3,7	8055
коксівне вугілля				5441,1	40,2	7455,0	42,2	2,4	5,6	-	-	28,7	8443	
				Ж	3890,4	40,8	5050,0	41,7	2,3	5,8	0,93	22	32,4	8295
				К	1486,6	39,2	2300,0	43,9	2,4	5,2	1,29	22	24,4	8755
				ПС	64,1	29,2	105,0	29,3	3,6	7,6	1,81	8	17,0	8705
Дніпропетровська область				13732,0	38,0	15144,0	38,2	1,6	11,1	-	-	41,5	8172	
у тому числі:														
енергетичне вугілля				12347,1	38,5	12543,8	38,8	1,5	12,1	-	-	41,7	8140	
				ДГ	10914,3	39,0	12250,7	38,9	1,4	12,2	0,57	8	41,8	8135
				Г	1432,8	34,4	293,1	33,0	2,1	7,9	0,75	10	40,1	8334
коксівне вугілля				1384,9	33,8	2600,2	35,5	2,0	7,0	-	-	40,6	8326	
				Г	567,4	32,8	53,3	33,2	1,2	10,2	0,61	9	39,6	8210
				ДГ	817,5	34,5	2546,9	35,6	2,0	7,0	0,75	11	40,6	8329
Волинська область														
енергетичне вугілля				ДГ	476,0	38,2	590,0	37,2	2,1	9,3	0,64	7	37,1	7857
Львівська область														
енергетичне вугілля														
				Г	2753,2	45,0	2630,0	47,6	2,3	5,8	-	-	36,7	8348
				Ж	2318,1	46,8	2314,0	48,3	2,2	6,1	0,9	14	36,8	8345
				Ж	435,1	35,3	316,0	43,0	3,3	4,0	0,9	21	36,1	8365

Table 33 – Coal extraction in mines and stripe mines in 2010.

This template shall not be altered. It shall be completed without modifying/adding headings or logo, format or font.



I ВИДОБУТОК ВУГІЛЛЯ ШАХТАМИ ТА РОЗРІЗАМИ

Найменування шахти	Дільова участь платів у видобутку вугілля по шахті у 2007 році, %	Марка вугілля ДСТУ 2472-96		Фактичний видобуток родового вугілля у 2007 році		Видобуток родового вугілля, що планується у 2008 році				Класифікаційні параметри			
		кокс.	сверг.	тис. т	Зольність А ^с , %	тис. т	Зольність А ^с , %	Серед. S ^с , %	Волога W ^с , %	Середній показник міцності вугілля R _с , %	Товщина пластинчатого шару У, мм	Вміст летючих речовин на сухий стан у ^с , %	Вміст теплоти згорання Q _с ^с , ккал/кг
МІНБУГЛЕПРОМ УКРАЇНИ				75095,4	38,1	78243,6	38,4	2,1	8,0	-	-	28,1	8243
у тому числі:													
Підприємства Міністерства				42152,3	40,1	46000,0	39,2	2,2	7,1	-	-	24,0	8195
Непідприємства Міністерства				32943,1	35,9	32343,6	37,2	2,1	9,4	-	-	33,9	8311
сверглатиме вугілля				49145,3	39,0	53103,0	38,6	2,1	8,6	-	-	25,8	8153
Д				270,2	48,9	365,0	40,5	2,4	13,0	0,50	0	41,2	7700
ДП				8241,5	41,6	8465,0	40,1	1,9	11,2	0,61	8	42,6	8011
Г				16608,8	41,8	18780,0	41,8	2,6	8,4	0,76	10	40,7	8176
Ж				290,5	28,6	165,0	33,5	2,9	5,4	0,87	23	36,0	8377
П				7012,4	34,5	7183,0	34,4	2,7	5,6	2,40	0	10,1	8543
А				16502,5	37,0	17290,0	36,8	1,3	6,5	4,10	0	5,6	8088
Б				219,4	24,9	855,0	24,5	3,8	55,6	0,35	0	60,6	6999
коксівне вугілля				25950,1	36,3	25240,6	37,9	2,2	6,7	-	-	33,0	8449
Г				3228,4	35,4	3600,0	36,3	1,6	7,5	0,72	12	40,9	8386
Ж				11878,0	35,5	12657,6	37,3	2,8	6,5	0,93	25	35,0	8450
К				10141,9	37,5	8103,0	39,6	1,5	6,8	1,24	19	27,8	8400
ПС				701,8	38,6	880,0	36,3	3,0	6,8	1,65	10	20,0	8613

Найменування шахти	Дільова участь платів у видобутку вугілля по шахті у 2007 році, %	Марка вугілля ДСТУ 2472-96		Фактичний видобуток родового вугілля у 2007 році		Видобуток родового вугілля, що планується у 2008 році				Класифікаційні параметри			
		кокс.	сверг.	тис. т	Зольність А ^с , %	тис. т	Зольність А ^с , %	Серед. S ^с , %	Волога W ^с , %	Середній показник міцності вугілля R _с , %	Товщина пластинчатого шару У, мм	Вміст летючих речовин на сухий стан у ^с , %	Вміст теплоти згорання Q _с ^с , ккал/кг
Донецька область				33790,3	38,6	34598,6	38,2	2,3	7,0	-	-	28,5	8341
у тому числі:													
Підприємства Міністерства				19249,1	42,1	22270,0	39,8	2,4	7,1	-	-	31,1	8292
Непідприємства Міністерства				14541,2	34,1	12328,6	35,3	2,1	6,8	-	-	24,0	8430
сверглатиме вугілля				16282,4	40,4	19033,0	38,8	2,4	6,9	-	-	26,1	8280
Д				270,2	48,9	365,0	40,5	2,4	13,0	0,50	0	41,2	7700
ДП				2088,3	48,5	2265,0	41,9	2,3	8,9	0,69	8	41,6	7950
Г				5758,2	41,7	7760,0	40,7	2,7	7,4	0,85	13	39,9	8221
П				6302,3	35,1	6403,0	34,7	2,6	5,6	2,42	0	10,0	8540
А				1863,4	43,9	2240,0	40,6	1,0	6,3	3,73	0	6,5	8172
коксівне вугілля				17507,9	37,0	15565,6	37,5	2,1	7,1	-	-	31,5	8416
Г				657,0	37,2	870,0	35,0	1,2	6,0	0,92	12	39,9	8365
Ж				7133,9	36,6	6867,6	36,0	2,8	7,3	0,99	25	35,3	8457
К				9064,9	37,1	7003,0	39,3	1,5	7,0	1,24	17	28,2	8260
ПС				652,1	39,0	828,0	36,4	3,0	6,7	1,66	10	20,2	8607
Луганська область				25208,7	36,7	27075,0	37,7	2,1	6,8	-	-	18,6	8192
у тому числі:													
Підприємства Міністерства України				19387,6	37,1	20185,0	37,2	1,9	7,2	-	-	13,7	8075
Непідприємства Міністерства України				5821,1	35,0	6890,0	39,3	2,6	5,5	-	-	33,1	8531

Table 34 – Coal extraction in mines and stripe mines in 2008.



Annex 5

REFERENCE OF THE STATE STATISTICS SERVICE OF UKRAINE “ACTUAL EXPENSES OF ELECTRICITY FOR PRODUCTION OF ONE TON OF NON-AGGLOMERATED COAL”⁶⁴



**ДЕРЖАВНА СЛУЖБА СТАТИСТИКИ УКРАЇНИ
(Держстат України)**

вул. Шота Руставелі, 3, м. Київ, 01601
тел. (044) 287-24-22, факс (044) 235-37-39, телетайп 132-168, E-mail: office@ukrstat.gov.ua,
www.ukrstat.gov.ua

29.05.2012р. № 15/1-20/692/11 На № _____ від _____

Товариство з обмеженою відповідальністю
«Науково-дослідний центр КТФ»

01030 м. Київ, вул. Б. Хмельницького, 16/22

На Ваш лист від 23.05.2012р. № 12 Держстат у межах своїх повноважень надає наявну статистичну інформацію щодо фактичних витрат електроенергії на видобуток однієї тонни вугілля кам'яного неагломерованого.

Фактичні витрати електроенергії на видобуток однієї тонни вугілля кам'яного неагломерованого*.

	кВт.г/т			
	2008	2009	2010	2011
Україна	87,8	90,5	92,6	84,2

* Розраховано як частка від ділення фактичних витрат електроенергії на видобуток вугілля кам'яного неагломерованого за звітний період на обсяг видобутого вугілля кам'яного неагломерованого за звітний період, помножена на 1000.

Заступник Голови



Н.С. Власенко

Вик. Смєлєна В.П.,
тел. 287-36-81

⁶⁴ <http://ji.unfccc.int/UserManagement/FileStorage/NMPXTGSA7E4C095DHRJYUWLOI8Z3V1>

Annex 6**ADDITIONAL INFORMATION ON PROJECT PARTICIPANTS**

Organization:	“AGS-2008” LLC
Country of registration:	Ukraine
EDRPOU code (Uniform State Register of Enterprises and Organizations of Ukraine):	35710984
KVED types of economic activities (Code of economic activities according to the general classification of economic activities)	The first one is main: 60.24.0 – Activities of road freight transport; 50.20.0 – Maintenance and repair of motor vehicles; 63.40.0 – Organization cargo transportation; 51.90.0 – Other wholesale; 51.51.0 – Wholesale Fuel; 74.87.0 – Provision of other commercial services

Organization:	ProEffect OÜ
Country of registration:	Estonia
Date of registration:	18/06/2004